

GENERAL ASPECTS OF ROLL COOLING FOR HOT & COLD ROLLING MILLS

BY: HUBERTUS WENIG*

ABSTRACT

The paper describes how heat is generated in the roll gap, and how roll cooling should be applied on the rolls in the best manner. In many cases roll cooling goes along with lubrication. The characteristics of the various coolants used for roll cooling are explained with regard to cooling and lubricating effects. Depending of the type of rolling mill, dedicated roll cooling systems are required to fulfill the required functions. Examples are suitable roll cooling and lubrication systems to fully utilize the advantages of HSS rolls in hot strip mills, and selective roll cooling systems as a method to control the flatness of the strip in cold rolling mills. Cooling and lubricating is furthermore essential for the plate-out for cold rolled strip. Typical methods how to apply coolant onto the rolls are described and discussed. Various nozzle types and their characteristics such as cooling effect, lubrication and coolant distribution are described. Good roll cooling requires spray pattern engineering, the selection of suitable nozzles in combination with an optimum arrangement.

Keywords: Nozzle, spray, flow, cooling, selective roll cooling, rolls, lubrication, profile and flatness, surface temperature, water distribution, plate-out.

Thermal aspects of rolling

The plastic deformation of steel during the rolling process generates heat, which is absorbed by the work rolls – figure 1. Heat is carried by the rolling stock (by virtue of its temperature) and some is lost to the air and to the wash-off coolant before reaching the roll bite. In the roll bite the strip gains heat from friction between strip and roll and by the deformation of the metal. It loses heat by contact with the roll and it is this heat which must be dissipated by the roll coolant. Figure 2 shows modeled temperature distributions in a roll around its circumference during hot rolling of steel. The roll surface emerges from the bite at high temperature and is quickly cooled by conduction into the cooler inner parts of the roll. When the surface meets a spray there is a sudden depression in temperature and then a recovery after the spray. Below the surface the temperature distributions are very different and much less varied. There is also a delay in the features created by the delay in heat diffusing from between surface and roll bulk. The average temperature at all depths is the same when the roll is running in equilibrium. The very large temperature gradients through-depth give rise to thermal stresses in the roll and since these ultimate with every roll rotation, can cause fatigue failure of the roll material and the so-called "fire cracking".

As the rolled stock leaves the bite it loses further heat via air and wash-off. The strip may emerge at a higher or lower temperature than at entry, depending on the relative magnitudes of the heat gains and losses in the bite. In cold rolling, the heats of friction and deformation are usually large compared with losses due to conduction to the roll and so the strip would normally emerge hotter.

*) Area Sales Manager (Metallurgical Division), Lechler GmbH, D-72555 Metzingen/ Germany

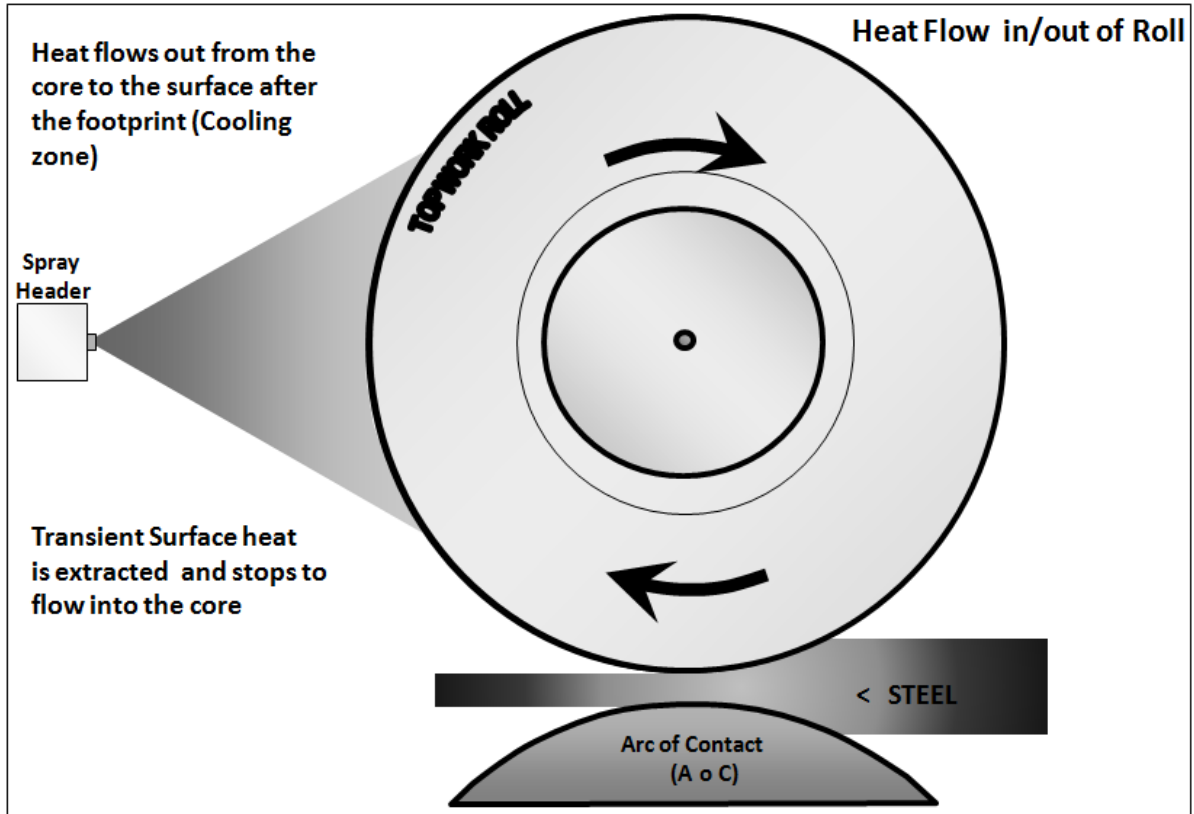

Figure 1 – Heat balance in the rolling bite.

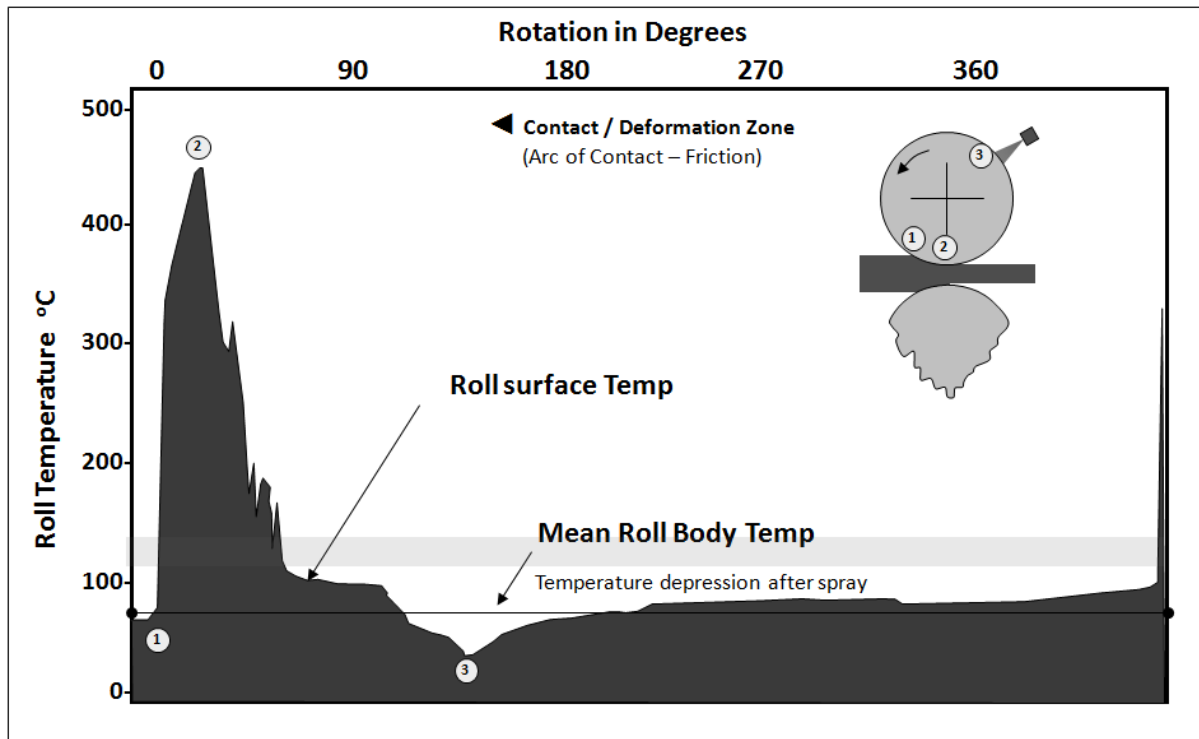

Figure 2 – Roll surface temperature distribution.

Coolants for steel rolling

For roll cooling applications of hot steel pure water is normally used as a coolant. The water is usually re-circulated in the plant and should have a sufficient filtration grade in order to prevent clogging of the nozzles. The maximum particle size should not exceed 1/3 of the smallest nozzle internal passage. In many cases roll bite lubrication with pure oil is applied in addition to water, to reduce the rolling loads and the mill vibrations and consequently improve the surface quality of the rolled product. Roll bite lubrication is especially recommended when using HSS rolls having a higher friction coefficient than high chrome rolls.

As cold rolling of steel requires a lubricant in order to fulfil the lubrication role, oil is necessary. Hence, water-oil mixtures are used with a percentage of oil in water of approx. 5%. In most cases emulsions are the common coolants for cold rolling, where the oil and the water form a pseudo-solution. There are stable and meta-stable emulsions. In other cases dispersions are used, in which oil and water remain separate and the oil particles are dispersed. In general, dispersions have larger (8-24 μm) and more uniform particle sizes and provide a lower iron fine generation. Emulsions have smaller (2-16 μm) and less uniform particle sizes giving a higher level of iron fine generation.

The oil separates from the water after hitting the roll surface and plates out to form a thin layer to fulfil its lubrication role. This oil plate-out is very important in obtaining proper lubrication and hence proper strip surface quality. If the rolls run too cold, insufficient oil plate-out may occur and strip surface suffers. Like for hot rolling, oil can be applied to the roll gap by so-called direct application. Pure oil is sprayed into the roll gap just before the bite.

For cold rolling of stainless steel water-based coolants cannot be used unless the coolant can be completely removed from the strip before it is coiled, otherwise it produces permanent stains on the surface. For this reason rolling oil is often used as the coolant/lubricant.

Water is an exceptionally efficient heat transfer medium due to its high density and specific heat capacity. However, its cooling effectiveness is soon reduced by the admixture of oil, so this effect must be incorporated into the quantity of coolant being utilized. 5% of oil in the water may sound negligible, but the heat transfer is compromised. Water/oil emulsions are, however still about four times more effective in terms of cooling than rolling oil.

The viscosity of the coolant has an influence on the spray developments using nozzles. At higher viscosity, which is normally the case with rolling oils, the spray angle reduces compared to using water. This effect must be considered when designing roll cooling arrangements, in order to ensure correct spray overlaps.

Functions of roll cooling

Roll cooling can have many functions. The main function is maintaining a good working temperature range for the rolls to avoid overheating and as a result the development of roll surface defects, which immediately can be found on the rolling product. A proper roll cooling is hence essential for a long roll life time, for extending the rolling periods to a maximum, for reducing roll changing and finally maximising the production output and product quality of the mill.

The roll profile can be divided into a fixed portion established by roll grinding, and into a flexible portion established by roll cooling – the thermal camber. By applying a proper roll cooling, the required thermal roll crown can be controlled in way to influence the overall roll profile. It is common practice adjusting the roll cooling to the strip width being rolled. Roll cooling is hence an actuator to allow stable rolling conditions of the mill. This is particular true for strip tandem rolling mills with regard to steering the strip, ensuring it remains in the mill centre.

In cold rolling applications roll cooling always goes along with lubricating of the roll gap, when using water-based emulsions or dispersions and rolling oil.

The so-called selective roll cooling is applied mainly for cold rolling mills to control the asymmetrical flatness deviations across the strip width. There are furthermore applications for special cast-rolling mills for narrow-gauge hot strip production. Normally, two rows of nozzles are used in one header. The row of nozzles directed to the roll gap is for the basic cooling and lubricating of the rolls. It can be adjusted from the centre outwards to match the strip width being rolled, and the flow rates used are approx. 20-30% of the header flow rate. The second row of nozzles has the function of selective cooling utilizing 70-80% of the total header flow rate. The zoning of the selective cooling nozzles is in conjunction with the shape measuring roll on the mill exit side. The relevant nozzles in the top and bottom header of the same zone are operated simultaneously, so that both top and bottom roll share the same reaction. Selective cooling has an immediate effect on the roll diameter in this particular zone, and hence on the roll profile. In order to achieve the required effect in time, in practise the temperature of the coolant should be at least 15°C cooler than the temperature of the roll surface.

Another function of roll cooling is washing away debris, produced by metal particles and oxides on the rolling stock or from other sources. In many cases these particles are harder than the rolling stock and hence debris should be washed off to ensure a good surface quality of rolls and rolled product.

HSS rolls, often installed in the earlier stands of hot strip mills, provide improved wear resistance along with a better surface roughing resistance. However, HSS rolls are more sensitive during operation and require a higher grade of attention with regard to roll cooling than High-Cr rolls. HSS rolls need an adequate mill operating environment to cope for their higher friction coefficients, their sensitiveness for rolled-in scale, for peeling, for cracking and for spalling. HSS rolls have furthermore a higher sensitiveness for mill chatter and for building up a thermal crown. The higher sensitiveness for peeling compared to High-Cr rolls can be described as follows. Peeling takes place when the oxide layers of the work rolls reach a critical thickness. An adequate roll cooling can reduce the growth of oxides by reducing the time of

exposure at high temperatures. It is hence recommended cooling down the roll surface as early as possible just behind the roll gap (600-800 °C) to approx below 300 °C. The optimum average work roll temperature should be in the range of approximately 50 – 70 °C. In addition, it is recommended to cool down the surface of the strip just after the exit of the previous stand. This so-called “skin cooling” or “anti-peeling spray” will further help to reduce work roll peeling.

Methods of applying coolant onto the rolls

There are many ways of applying coolant onto the rolls. In many rolling mills you can still find drilled pipes or crushed pipes applying the water onto the rolls, but this method cannot provide an even liquid distribution and consequently an effective roll cooling condition.

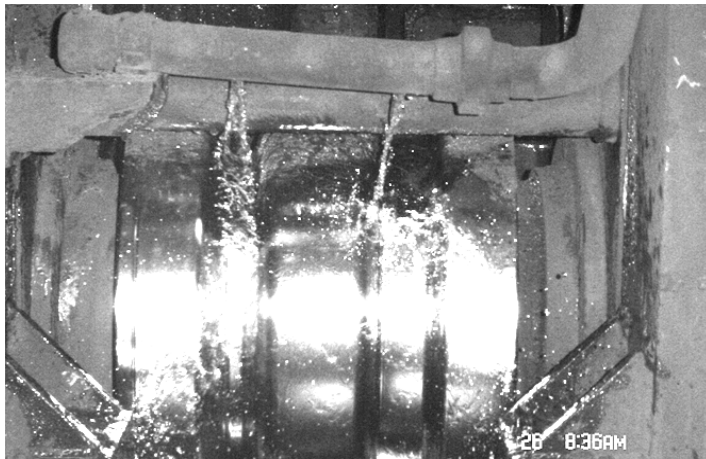

Applying the required water at a given pressure, many single bores are required, having small diameters and hence can clog easily. The spray direction and the amount of water being sprayed are not defined and not reproducible – see figure 3.

Figure 3 – Drilled pipes for roll cooling in section mills.

Nozzles for roll cooling provide a defined spray footprint, spray angle and flow rate in [l/min] at a certain pressure [MPa]. The roll cooling can be documented and becomes reproducible. Nozzles, especially flat jet nozzles, provide a high impact density and large droplet sizes, which can impinge through the layer of water on the roll surface.



Using nozzles and a good nozzle arrangement can make the roll cooling process much more effective. This can lead to a remarkable reduction of the coolant volume being used and at the same time to a reduction of the roll temperatures – figure 4.

Figure 4 – Spray header with flat jet nozzles for roll cooling in section mills.

Spray cooling arrangements

Hot mills generally need more cooling and it is an advantage to have exit sprays as well as entry sprays. However, the exit sprays have more effect because the roll surface temperature is higher on the exit side. As a rule of thumb, the exit side cooling flow rate should be in the range of $2/3$ of the total mill flow rate – figure 5. It is of major importance to cool the work roll, as the heat generated by the rolling process is taken over by the work rolls. The back-up rolls are not in direct contact with the rolled stock and pick up the heat from the contact with the work rolls and by friction between the roll surfaces. As a result, back-up (and intermediate rolls) require only a small amount of cooling. Here the coolant application has mainly the function of washing-off debris and lubricating. In some cases, only the top back-up rolls are cooled, as the bottom back-up roll receives coolant from the work rolls.

Cold mills, if it is the final stand, generally have cooling nozzles only on the entry side of the mill – figure 6. This is because coolant entrained into the coils can produce staining when the coils are later annealed so that the less coolant in the surface between the mill and the coil the better. Some coolant can leak round near the strip edges especially with thicker strip and this must be removed before the strip reaches the coil. Air blow-off nozzles are commonly used for coolant removal.

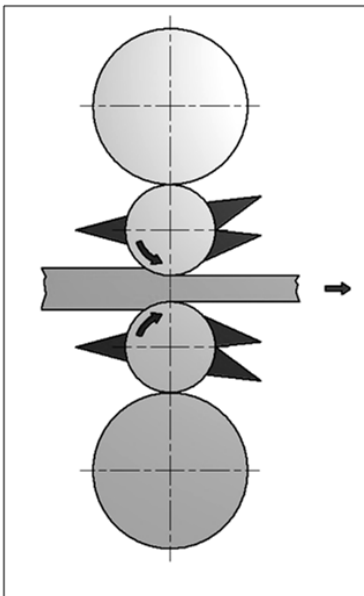

Figure 5 – Typical hot strip mill.

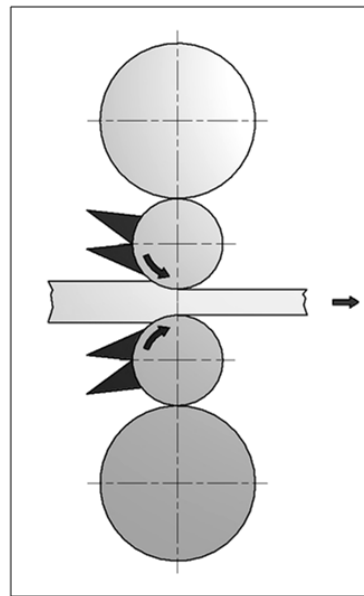

Figure 6 – Typical cold strip mill (final stand).

Nozzle types for roll cooling

There are two major nozzle types used for roll cooling, full cone and flat jet nozzles – figure 7. Full cone nozzles have a large footprint, which normally has a round shape, but also can be oval, square and rectangular. The droplet sizes are generally smaller compared to flat jets. In order to have an even distribution of droplets across the spray, special x-vane inserts are required, creating internal turbulences. Without using special inserts, the spray would have a hollow-cone characteristic.

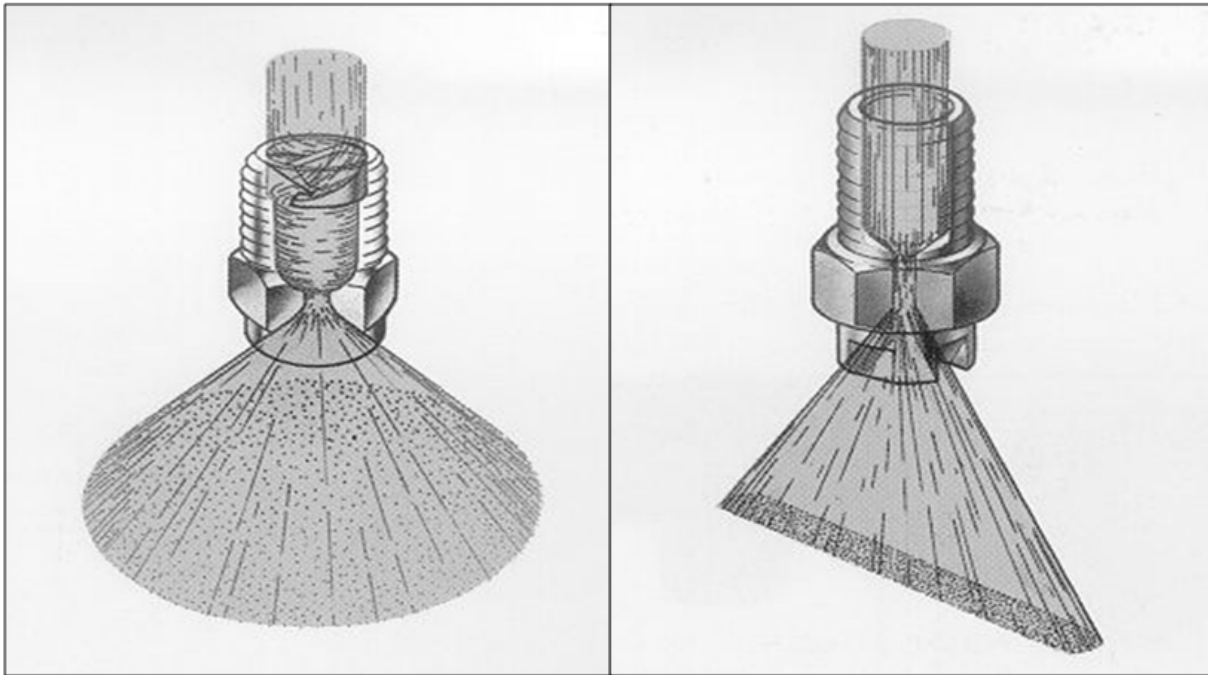

Figure 7 – Typical full cone nozzle and flat jet nozzle.

Full cone nozzles with round footprint do not require alignment, and hence thread connections are normally used. Under some conditions full cone nozzles do provide a better heat transfer from the rolls compared to flat jet nozzles of similar capacity [l/min] and spray angle. This is related to the larger footprint area providing a longer dwell time of the revolving roll under the spray. Full cone nozzles can be a good solution for section rolling mills for long products, where one nozzle covers one roll section only. Arranging several full cone nozzles in one row however can be difficult, as it is required to ensure a sufficient overlap. That means, the nozzle footprints interfere to each other. As a result, the liquid distribution across the roll barrel may become uneven, and consequently the roll thermal profile and lubrication may be compromised – figure 8.

Flat jet nozzles provide larger droplets which form a flat footprint. They have higher impact [N/mm²] and can therefore impinge better through the layer of coolant, which normally cover the rolls. The internal geometry does normally not require any inserts, and hence the risk of clogging using flat jet nozzles is reduced. However, in order to ensure correct alignments and overlaps on the roll surface, it is not recommended using flat jet nozzles with thread connections, as it is difficult ensuring the correct nozzle orientation on the header. Instead, flat jet nozzles with self-alignment fixing systems should be used. As the cooling time is essential for the cooling effect, the covered roll surface should be as large as possible. In practice, this can be achieved by selecting suitable spray angles and offset angles. Taking advantage of the parabolic liquid distribution of a single flat jet nozzle, a very even liquid distribution on the roll surface can be achieved, while the nozzle footprint areas do not interfere to each other – figure 9. Hence, in most cases, flat jets are the preferred nozzles types for roll cooling.

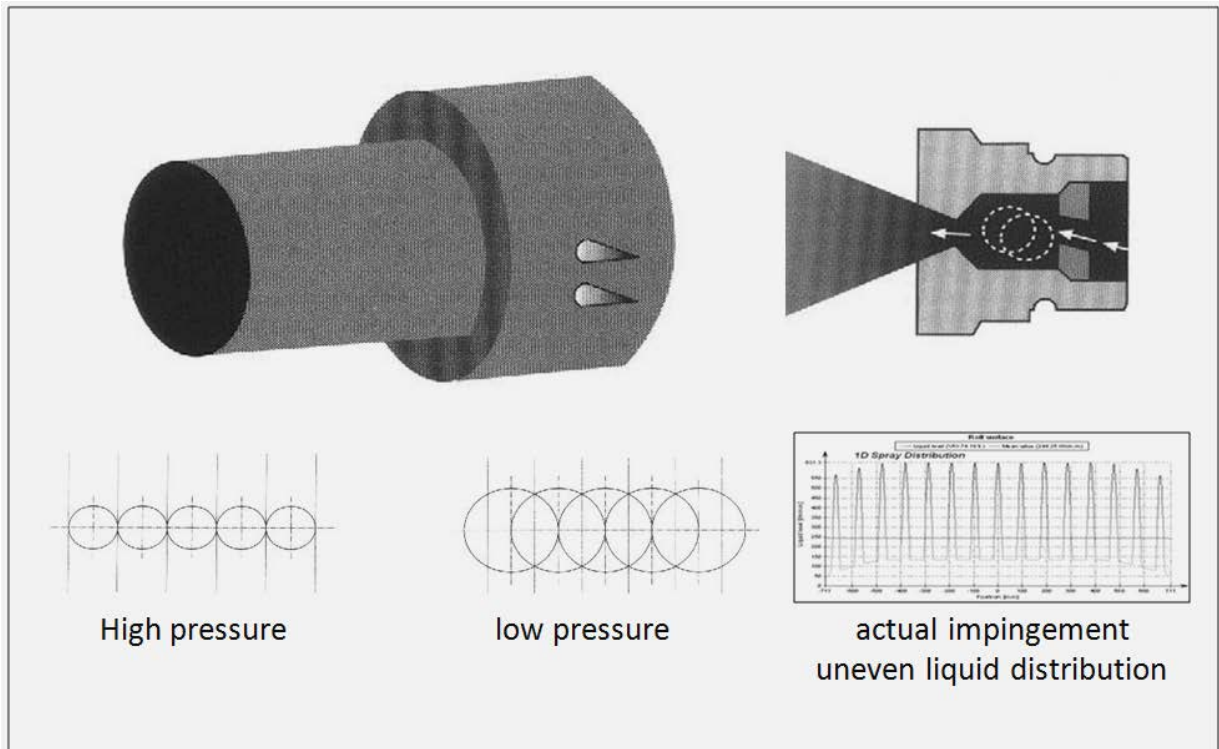

Figure 8 – Nozzle arrangement on a roll using full cone nozzles.

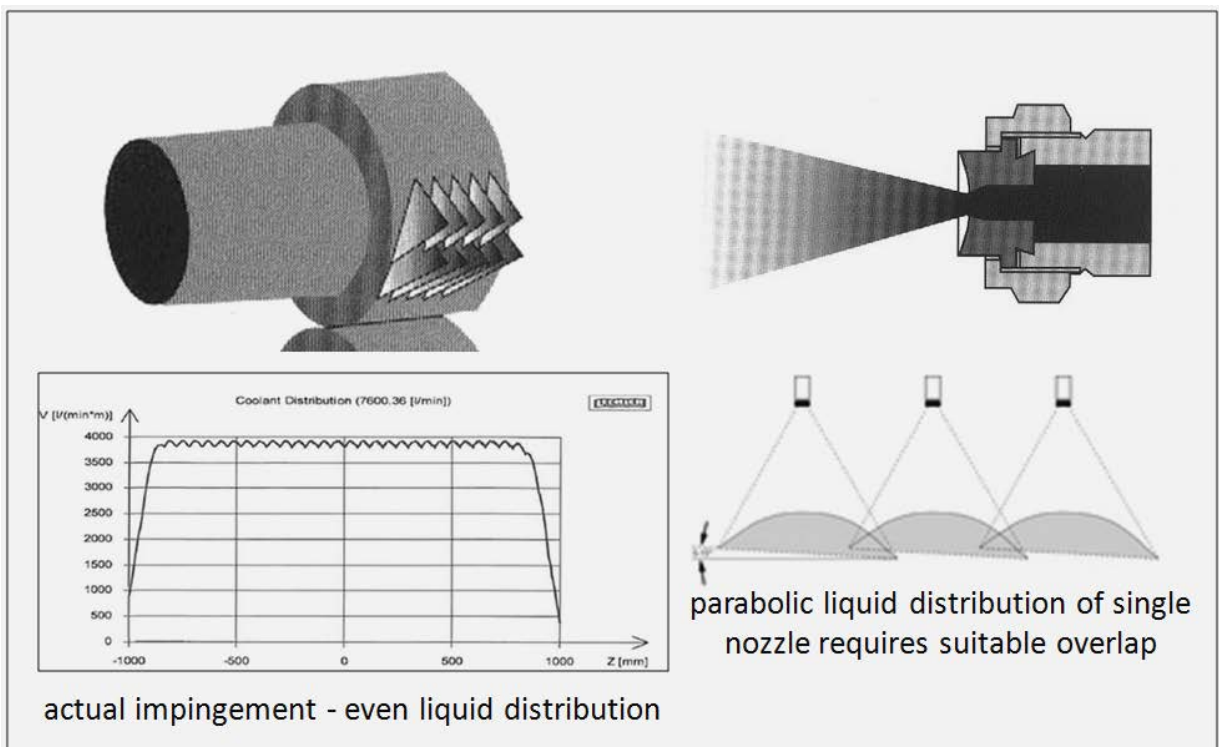
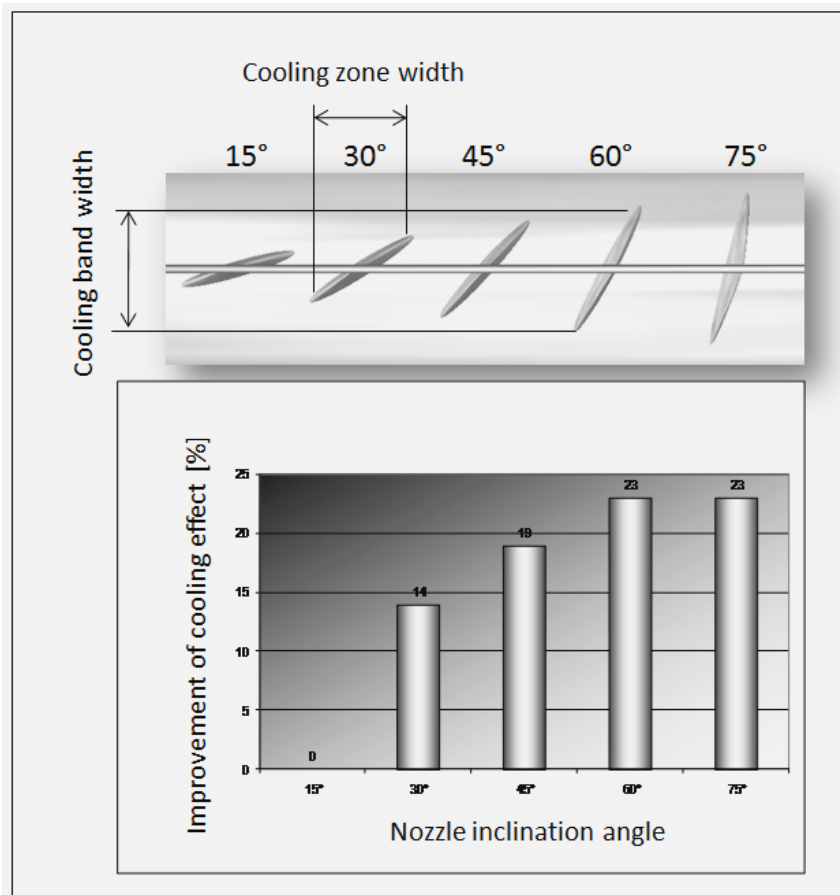

Figure 9 – Nozzle arrangement on a roll using flat jet nozzles.

Nozzle arrangements

The time for the covered roll surface under the spray is normally very short due to the high circumferential speed. Therefore it is important to maximize the sprayed surface area.



At a given speed, the cooling time is increasing with the covered surface. This can be achieved by selecting suitable nozzle offset angles – figure 10. The steeper the nozzles are the larger will be the cooling band width (vertical). On the other hand, the cooling zone width (horizontal) is becoming smaller.

Experiments have shown that the optimum cooling effect can be reached at an offset angle of approx. 60° to the horizontal. Increasing the offset angle further to 75° showed a lower cooling effect.

Figure 10 – Cooling efficiency of flat jet nozzles as a function of the offset angle.

This can be explained by the increasing spray height causing lower impact and heat transfer on the outer nozzle areas due to the roll geometry. The spray height is small in the center and is larger in the outer areas. In practice, the optimum nozzle arrangement must be in accordance with the rolling mill design, as roll guides, band presses and other mechanical equipment often only leave a small free roll area, which can be utilized for spray coverage. Furthermore, pass line changes and different roll diameters need to be considered. The available area for roll cooling should be determined in order to maximize the roll cooling conditions.

At small cooling zone widths as a result of steep offset angles, it is required to apply the correct nozzle pitch – figure 11. An optimum nozzle pitch can be achieved, when the nozzle footprints do not interfere to each other and an even liquid distribution across the roll barrel is ensured.

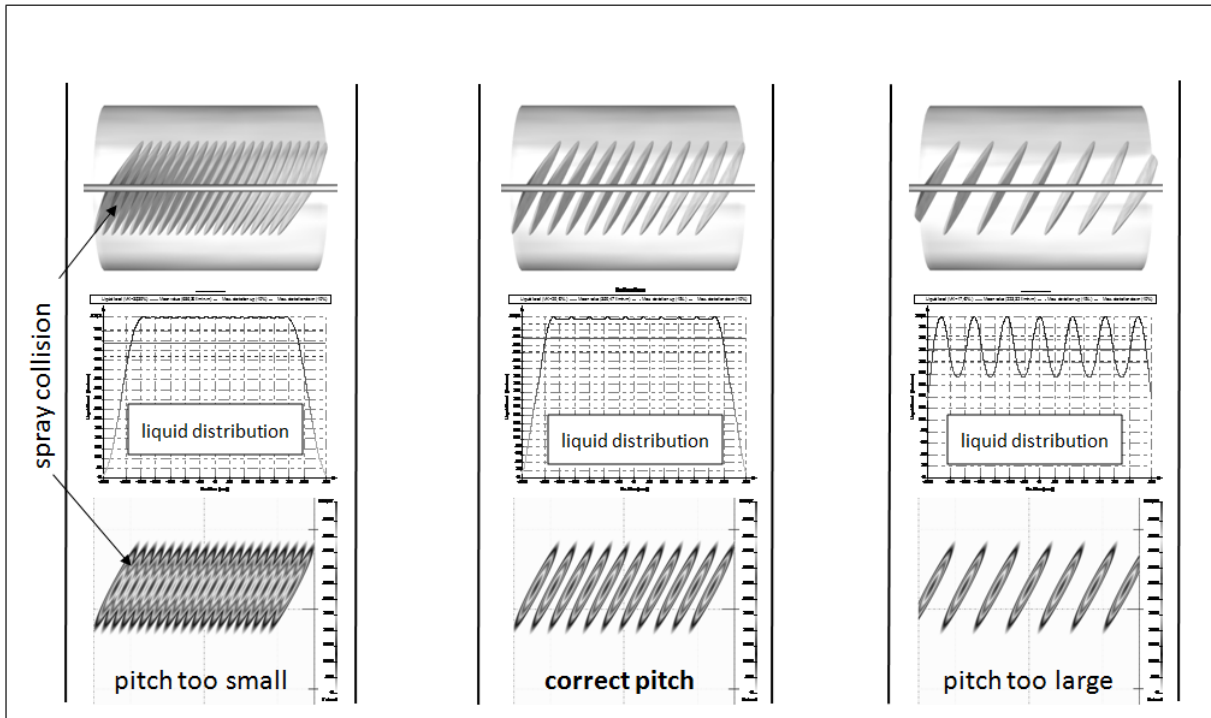

Figure 11 – Cooling zone widths of flat jet nozzles and nozzle pitch.

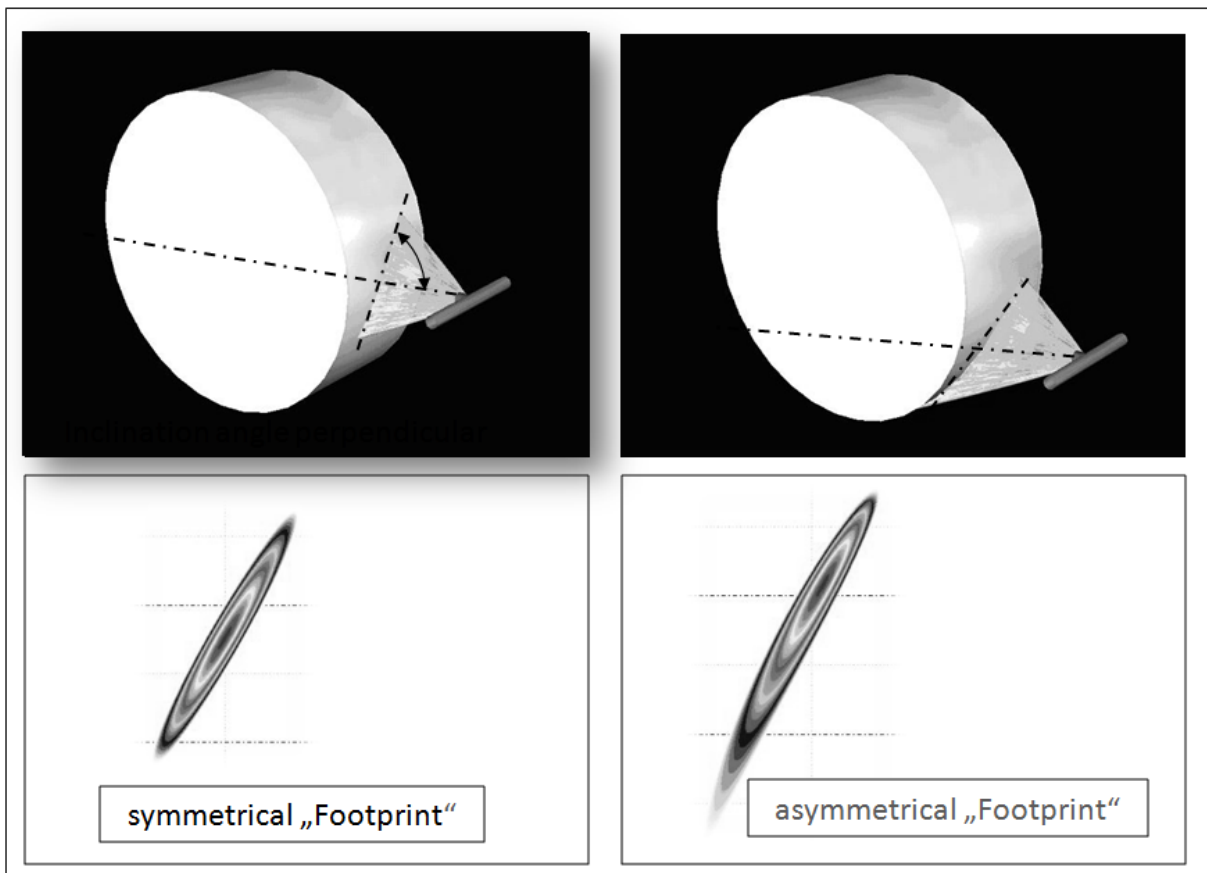

Figure 12 – Symmetrical footprints by inclination angle perpendicular to roll axis.

Besides the nozzle spray angle and the offset angle, the inclination angle of the nozzle related to the horizontal mill centre line is important. Asymmetrical footprints lead to uneven cooling and lubrication conditions and hence should be avoided. It is recommended directing the nozzles perpendicular to the rolls, in order to achieve symmetrical spray footprints – figure 12 – as well as the highest HTC heat transfer coefficient - figure 13.

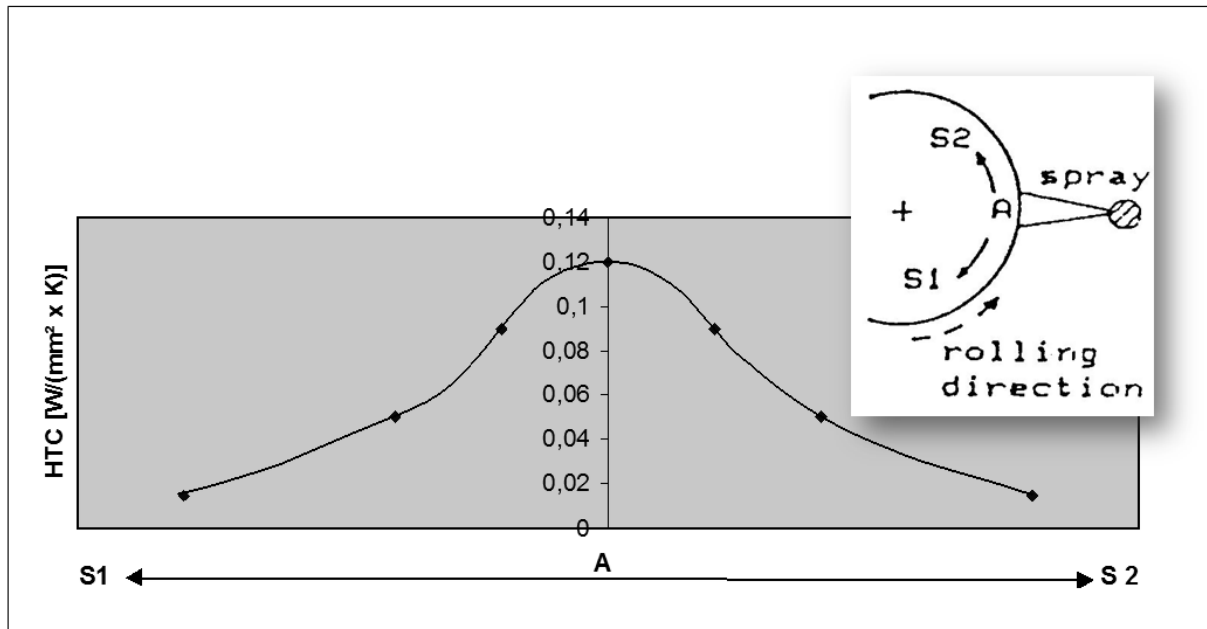

Figure 13 – Heat transfer coefficient as a function of inclination angle.

An easy and practical method how to check the nozzle footprints on the roll is the “grease test” – figure 14. The rolls are covered with a layer of grease, the roll set is installed in the mill and the sprays are activated for a short time. After removing the rolls out of the mill, the nozzle footprints can be visualized. Another method is using plastic laminated paper normally used for packing of coils and sheets. The laminated side is used inside laying on the roll surface, while the paper side is outside and will be washed away by the nozzle footprints.

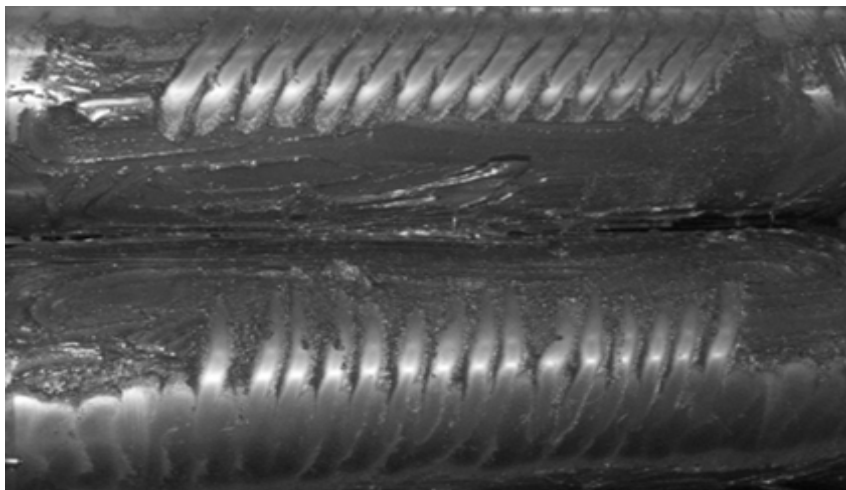

Figure 14 – “Grease test” for checking nozzle footprints.

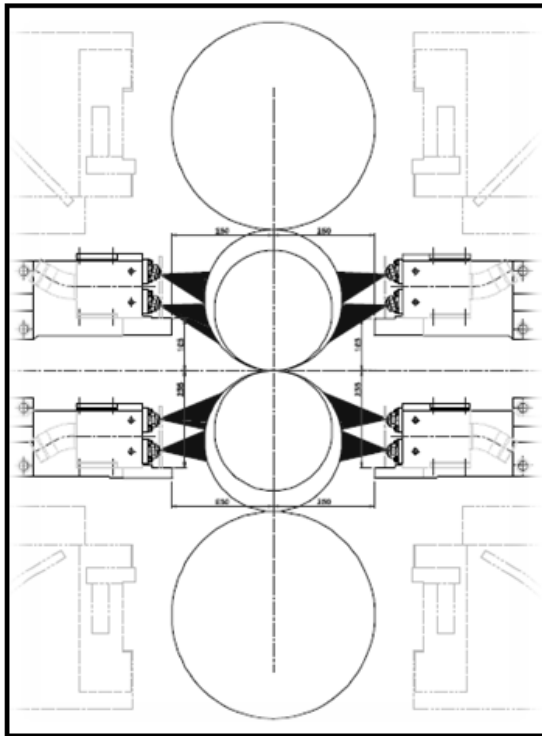

Figure 15 – Symmetry of cooling

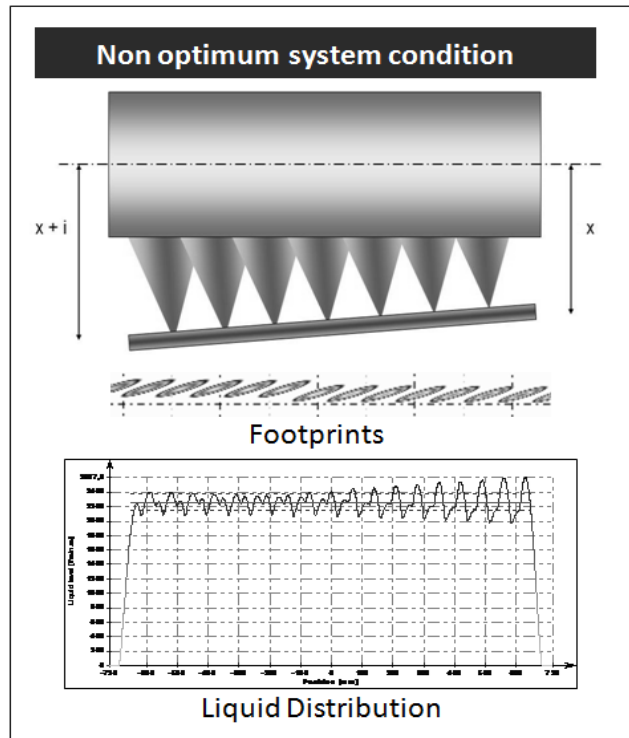
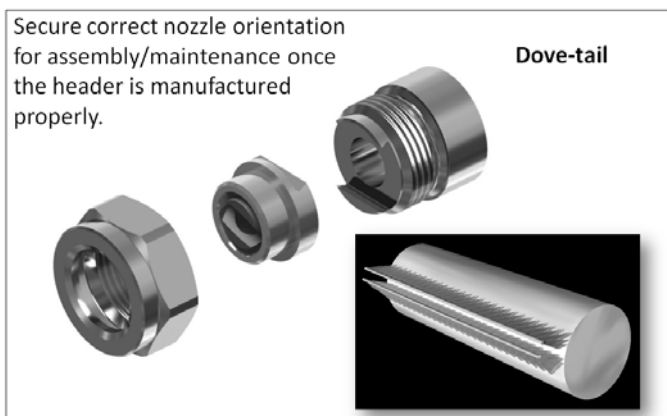

Figure 16 – Header alignment.

In order to ensure that top and bottom roll share the same reaction, the spray application should be symmetrical on top and bottom side. Entry and exit side may be different – figure 15.

Unaligned headers – figure 16 – can lead to different nozzle footprints on the roll drive and operator side, causing uneven cooling and lubricating conditions. As a result, deviations of the roll profile occur and the strip steering mainly in tandem mills may become an issue. Furthermore, the strip flatness, profile and the strip surface quality may suffer as well. Therefore it is recommended to check the headers for any misalignments on a regular basis. In order to meet the requirements for an effective roll cooling, flat jet nozzles with self-alignment are in most cases the suitable choice, as only self-aligning nozzle designs provide the operation safety required in a modern rolling mill. The dove-tail connection has been proved in practice and is common for hot as well as for cold rolling mills – figure 17. The nozzle assembly consists of the



welding nipple, which becomes part of the header, the nozzle tip and the lock nut. There are no seals required. Alignment tips assist to achieve an even alignment of the nipples when fabricating the headers, and can also be used for doing the header pressure test. Furthermore, alignment tips can later be used for blocking off certain nozzles positions on the sides, should that become necessary.

Figure 17 – Typical self-aligned nozzle with dove-tail.

Because of the modular design, changing to another nozzle having a different spray angle and/or capacity is possible. Besides the proven dove-tail design, other alignment systems for nozzles are available – figures 18 & 19.

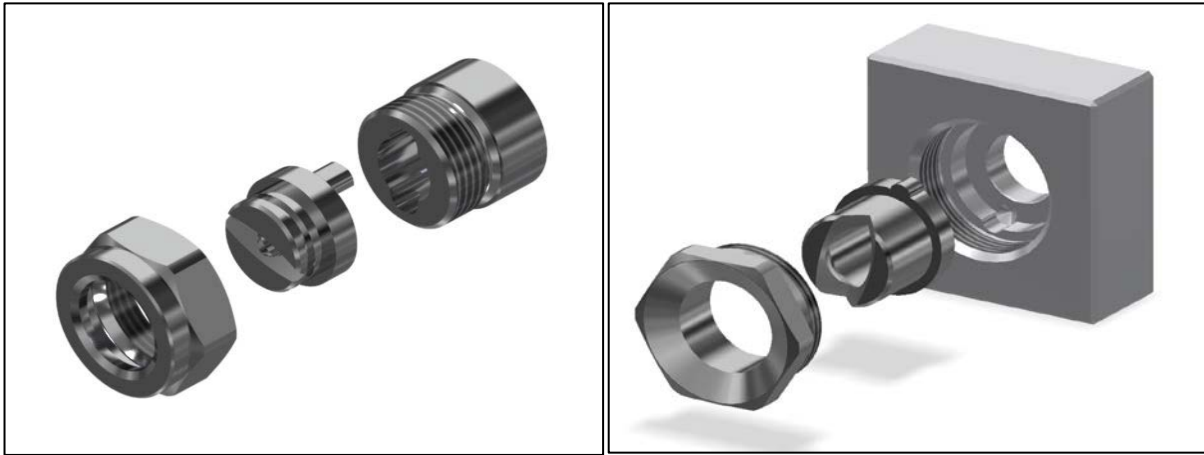

Figure 18 Self-alignment “locating lugs”. **Figure 19 – Self-alignment without welding.**

Two locating lugs – figure 18 – provide the self-alignment function and seal metallicly with a circular surface against the welding nipple when the nut is tightened. No torque is applied on the lugs themselves, preventing mechanical damage due to over-tightening of the nut. Unlike the dovetail assemblies, the tip is put in axial direction of the welding nipple. This allows safe and one-hand nozzle tip mounting, because the thread engagement does not take place before the two location lugs have been correctly positioned on the opposite nipple side.

Another example for self-aligned nozzles is shown in figure 19. No welding is required, because the tip geometry is machined directly into a front plate of a box-type spray header, ensuring the correct nozzle offset angle. The two keys on the nozzle tip are always in line with the flat jet spray axis. A hollow locknut holds the nozzle tip in place. This design makes welding nipples obsolete and allows the design of simple and cost-saving headers. Another positive aspect is the reduction of the overall header weight and outer dimensions of the box-type headers.

Conclusion

The effect of roll cooling is in many cases underestimated. The thermal balance of a roll during operation is a complex situation, as there are many sources of heat going in and going out. The type of coolant to be used determines the cooling and the lubrication effect. Avoiding roll surface defects and ensuring a long roll life time is the main purpose of roll cooling. Rolling mills require dedicated roll cooling and lubricating systems. A special application is the selective roll cooling for the control of profile and flatness for the strip. Although full cone nozzles can provide advantages with regard to heat transfer, in most cases flat jet nozzles are used, as they can be better arranged to provide an even liquid distribution across the roll barrel. The symmetry of cooling is essential to ensure that top and bottom roll share the same reaction for establishing a symmetrical roll profile and lubrication conditions. It is recommended to do a “spray pattern engineering”, determining the optimum utilization of the available space in the rolling mill. Flat jet nozzles with self-alignment systems should be the preferred nozzle type, as the nozzle alignment is essential for reproducible lubricating and cooling conditions.

References

Gary Boulton, R.G. Davies, W.J. Edwards, P. Steigler, G.A. Wallace, Auditing Rolling Mills Performance, SEAIISI Quarterly 2004 Vol 33 No. 1

G. Van Steden and J.G.M. Tellmann – Hoogovens Technical Services BV, A new method of designing a work roll cooling system for improved productivity and strip quality

From trials by Robinson and Westlake as presented by Ginzburg “Friction and Lubrication”

Mario Sinnaeve, R&D – Quality Control Manager, Marechal, HSS Work Rolls for Hot Finishing Stands: Key to Success, AISTech 2010

Gordon Downey, Lechler Ltd, Selective Differential Roll Cooling In Relation To Strip Flatness And Shape Control, The Control Of Profile And Flatness, Birmingham 1996