

*ENGINEERING
YOUR SPRAY SOLUTION*

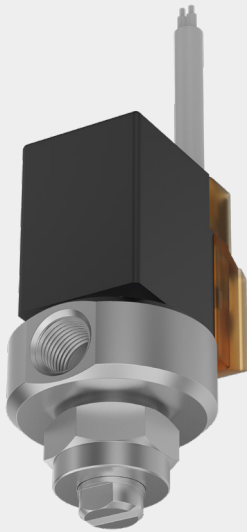

NEW

Solenoid valve Series 166H



- Compact solenoid valve
- Flexible in use
- Large variety of nozzles for various applications



The stainless steel housing in combination with a solenoid valve allows a flexible timing of the spray application.

Applications:

- Coating and cleaning
- Surface treatment
- Humidification
- Lubrication processes

Scope of delivery:

- Solenoid valve with body, power cable (5 m plugged cable) and retaining nut
- Nozzle must be ordered separately

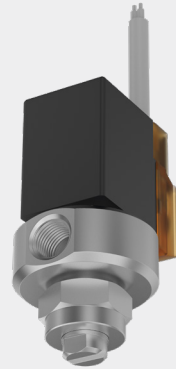

Series 166H

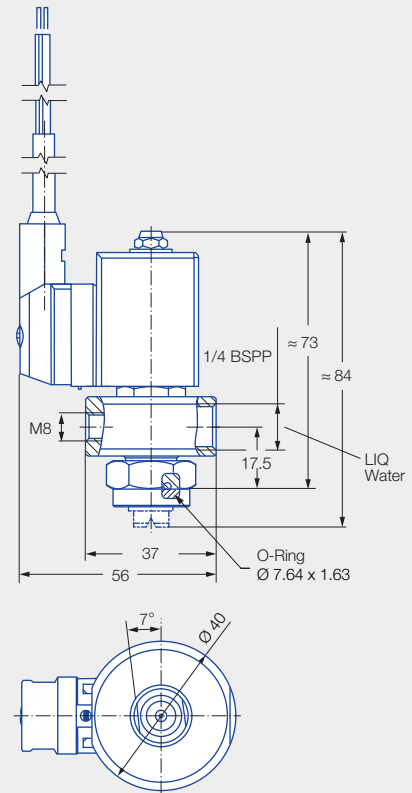

Material:

Body: stainless steel 1.4404
Inner parts: stainless steel 1.4404, 1.4301, 1.4113
Sealing material: FKM (FDA compliant)

Water flow rate:

Max. 6.5 l/min at 5 bar

Max. operating pressure:

10 bar

Power:

8 W

Voltage:

24 V DC

Protection class:

IP 65

Max. switching frequency:

500/min at 5 bar

Ordering no.
166.000.1Y.H1.00.0

	Type	Suitable nozzle size up to	Spray pattern	Spray angle	Material
	226	285	Hollow cone	60°/90°	1.4305
	468	68X	Full cone	60°/90°/120°	1.4571/1.4404 2.0401 PVDF
	684	608	Flat fan (tongue type nozzle)	140°	POM PVDF
	652	64X	Flat fan	20°/30°/45° 60°/75°/90° 120°	1.4305 1.4571/1.4404 2.0401
	Detailed information on the dovetail version can be found on the next page.				

Your benefits

- Quick and simple nozzle change by using a retaining nut
- Simple spray adjustment
- Flexible design, therefore flat fan nozzles, hollow cone nozzles and full cone nozzles can be used
- With integrated O-ring for sealing between nozzle and valve

**ENGINEERING
YOUR SPRAY SOLUTION**



Features:

- Nozzle body design fluidically optimized for pulsed operation
- Positioning takes place via attached dovetail
- Flow rate and spray angle identical to standard nozzle series 652

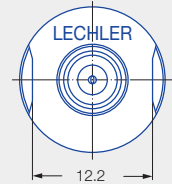
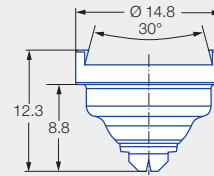
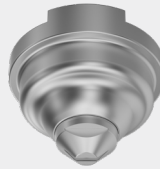

Series 652.XXX.16.56

	Type	Suitable nozzle size up to	Spray pattern	Spray angle	Material
	652.XXX.16.56	64X	Flat fan	20°/30°/45° 60°/75°/90° 120°	1.4305

Please refer to the data of the 652 series on pages 4.16 + 4.17 for the nozzle size (flow rate and spray angle) in our main catalogue.

**Example of ordering: Type + Nozzle size = Ordering no.
652.XXX.16.56 + 301 = 652.301.16.56**

ENGINEERING
YOUR SPRAY SOLUTION



LECHLER WORLDWIDE

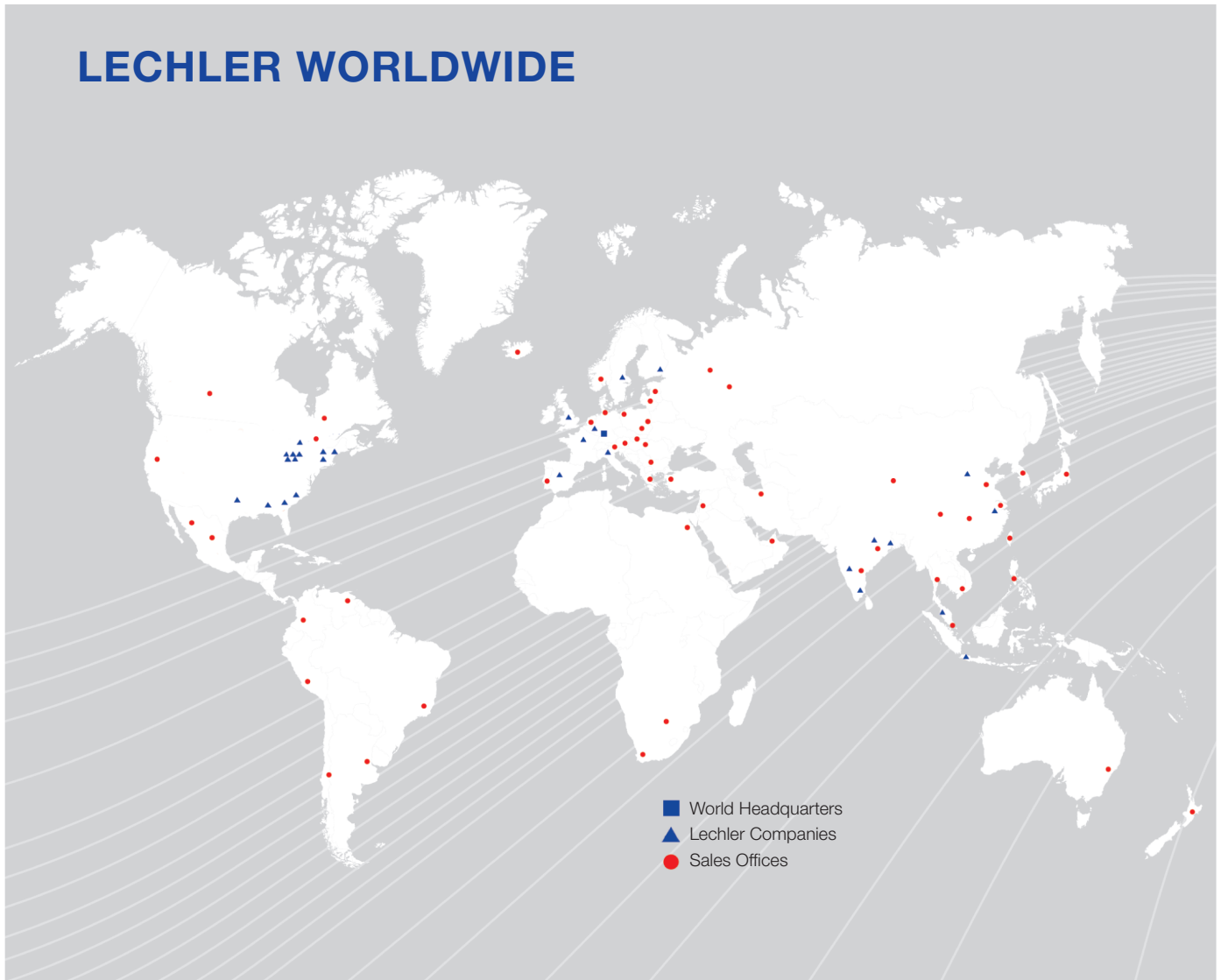

Lechler GmbH · Precision Nozzles · Nozzle Systems

P.O. Box 13 23 · 72544 Metzingen, Germany · Phone: +49 7123 962-0 · Fax: +49 7123 962-444 · info@lechler.de · www.lechler.com

ASEAN: Lechler Spray Technology Sdn. Bhd. · No. 23, Jalan Teknologi 3/3A · Taman Sains Selangor 1 · Kota Damansara, PJU 5 · 47810 Petaling Jaya · Malaysia · info@lechler.com.my

Belgium: Lechler S.A./N.V. · Avenue Newton 4 · 1300 Wavre · Phone: +32 10 225022 · Fax: +32 10 243901 · info@lechler.be

China: Lechler Intl. Trad. Co. Ltd. · Beijing · Rm. 418 Landmark Tower · No. 8 Dong San Huan Bei Lu · Phone: +86 10 84537968, Fax: +86 10 84537458 · info@lechler.com.cn

Finland: Lechler Oy · Ansatie 6 a C 3 krs · 01740 Vantaa · Phone: +358 207 856880 · Fax: +358 207 856881 · info@lechler.fi

France: Lechler France, SAS · Bât. CAP2 · 66-72, Rue Marceau · 93558 Montreuil · Phone: +33 1 49882600 · Fax: +33 1 49882609 · info@lechler.fr

Great Britain: Lechler Ltd. · 1 Fell Street, Newhall · Sheffield, S9 2TP · Phone: +44 114 2492020 · Fax: +44 114 2493600 · info@lechler.com

India: Lechler (India) Pvt. Ltd. · Plot B-2 · Main Road · Wagle Industrial Estate · Thane (W) - 400604 · Phone: +91 22 40634444 · Fax: +91 22 406344988 · lechler@lechlerindia.com

Italy: Lechler Spray Technology S.r.l. · Via Don Dossetti 2 · 20080 Carpiano (Mi) · Phone: +39 02 98859027 · Fax: +39 02 9815647 · info@lechleritalia.com

Spain: Lechler S.A. · Avda. Pirineos 7 · Oficina B7, Edificio Inbisa I · 28700 San Sebastián de los Reyes, Madrid · Phone: +34 91 6586346 · Fax: +34 91 6586347 · info@lechler.es

Sweden: Lechler AB · Kungsängsvägen 31 B · 753 23 Uppsala · Phone: +46 18 167030 · Fax: +46 18 167031 · info@lechler.se

USA: Lechler Inc. · 445 Kautz Road · St. Charles, IL, 60174 · Phone: +1 630 3776611 · Fax: +1 630 3776657 · info@lechlerUSA.com