

ENGINEERING
YOUR SPRAY SOLUTION



SELECTOSPRAY

Tailor-made roll cooling systems

METALLURGY

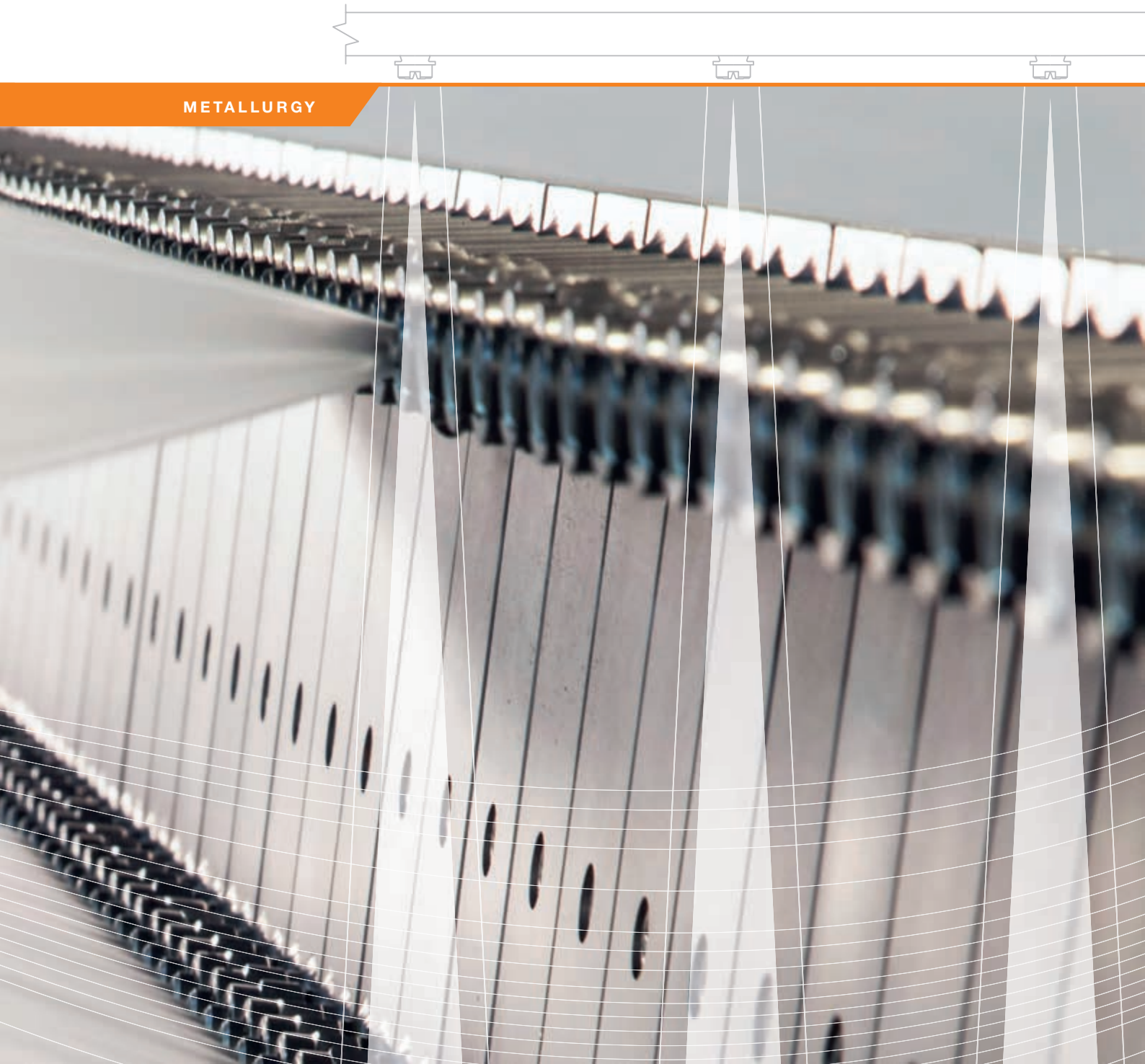



KEEP YOUR COOL IN THE ROLLING PROCESS

Today, operators of rolling mills are confronted with three main challenges:

- Produce thinner rolled products
- Achieve higher rolling qualities with different materials
- Increase efficiency

Smaller roll thicknesses with the same nominal gauge require greater reductions on the individual roll stands as well as a sufficiently fast rolling speed. All this requires stable conditions at the rolling gap. Greater rolling forces mean more friction and heat. That heat has to be controlled to avoid localized heat zones and roll deformation – and thus quality losses.

In addition to higher reduction rates, there also is the requirement to roll an increasingly wide range of different cross sections in different material hardnesses. Here, too, precise temperature control plays a decisive role. And finally, there is the question of efficiency. Quality alone does not ensure competitiveness. It also requires a sufficiently fast rolling speed and inexpensive coolant and electricity consumption.

All these aspects can be optimized by a well-designed roll cooling system tailored to the specific plant.



CONTENTS

Our four pillars for your success	4
Our common ground: Rolling fundamentals	6
SELECTOSPRAY The right choice	10
SELECTOSPRAY pneumatic systems	
Modulax TS and Mini Modulax TS	14
Pneumatic control hoses	16
Spray headers and nozzles	17
SELECTOSPRAY electropneumatic systems	
Modulax DSA and Mini Modulax DSA	18
Electrical control hoses	20
Spray headers and nozzles	21
SELECTOSPRAY electric systems	
EVA and Mini EVA	22
Electrical control hoses	24
Spray headers and nozzles	25
Services We keep your business rolling	26

OUR FOUR PILLARS FOR YOUR SUCCESS

As Europe's No.1 manufacturer of spray nozzles and technology, we offer the metallurgical industry not only a wide variety of spray nozzles but decades of experience, especially in the field of roll cooling. We therefore see ourselves less as a nozzle producer but rather as your competent partner for the optimization of your rolling processes.

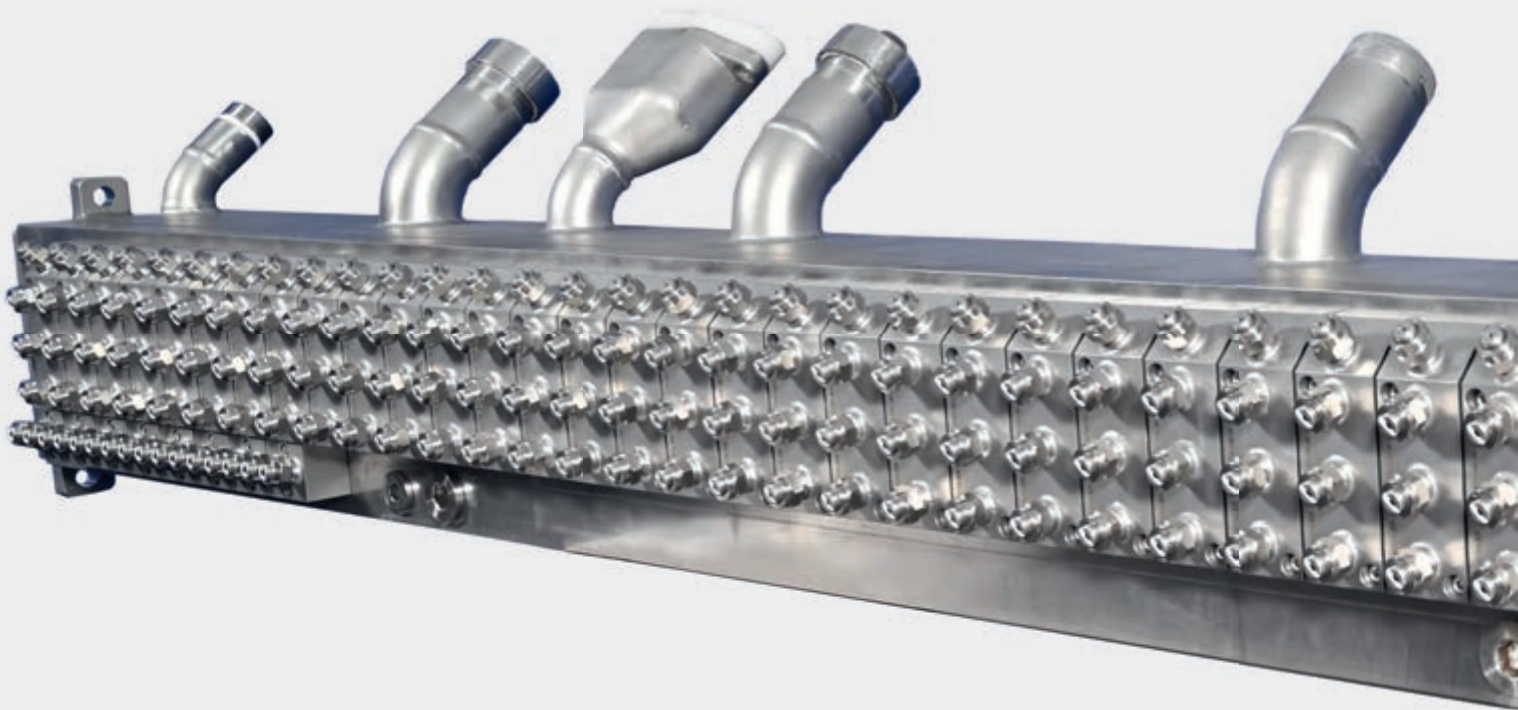

In-depth process understanding

Having engineered hundreds of selective roll cooling systems in steel, aluminum and non-ferrous rolling mills and having revamped a large number of conventional roll cooling systems in hot and cold rolling mills, Lechler knows the processes and demands of the metal industry.

Comprehensive design and testing capabilities

Using state-of-the-art methods such as computational fluid dynamics (CFD), finite element analysis (FEA), thermal modeling and spray simulation, we can replicate your individual situation and run through various optimization measures. In this way, we identify the most efficient solutions without having to interfere with the running processes.

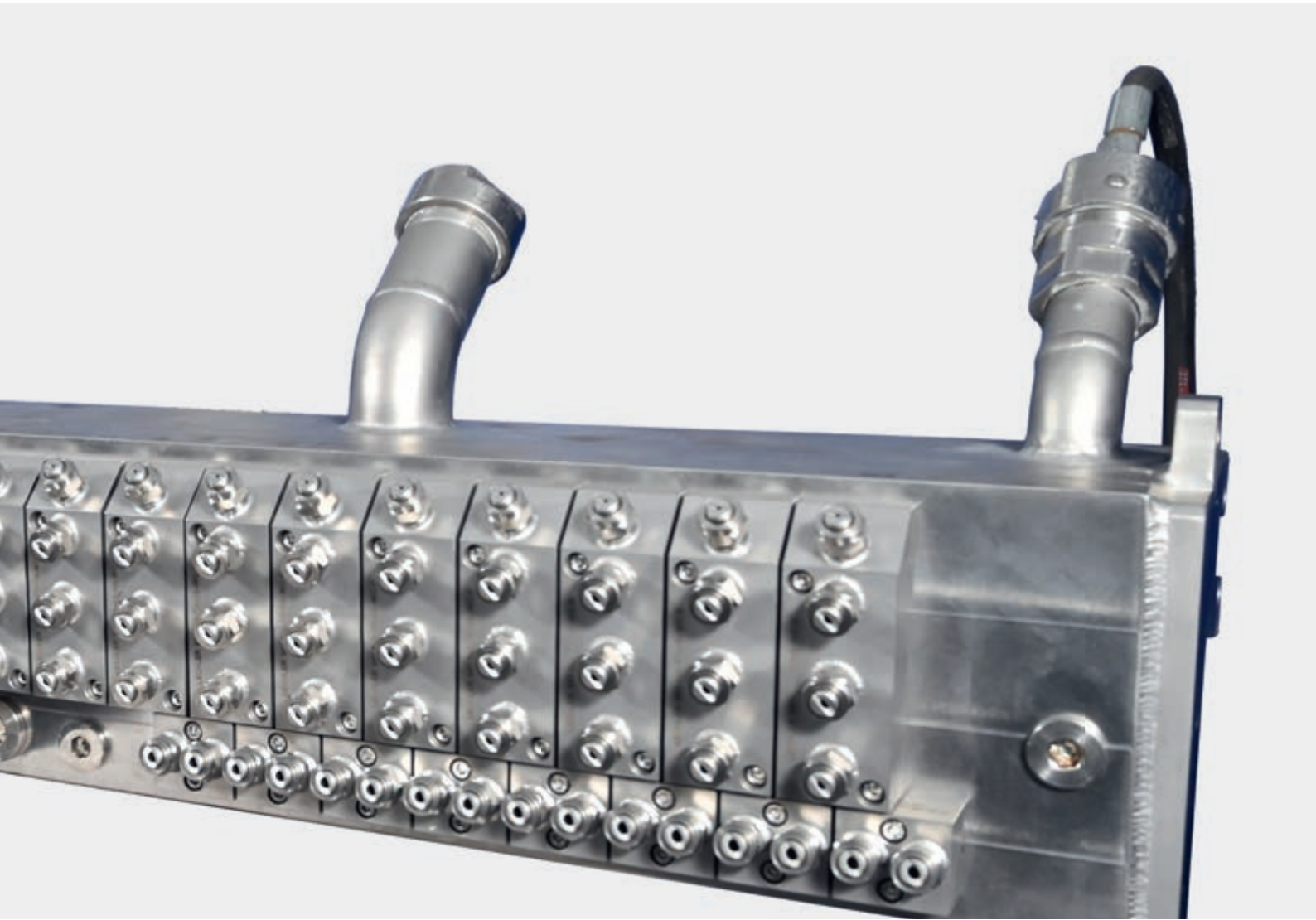

Broad product portfolio

With special nozzles made from an array of different materials, Lechler offers a complete nozzle program for all spray applications in metallurgy – ranging from casting and roll cooling, descaling to strip processing. We help you to achieve optimum results with the lowest possible amount of energy and spraying media, thereby reducing production costs as well as the plant's CO₂ emissions at the same time.

Worldwide presence

With production facilities in Germany, China, the USA, India and Hungary, we support rolling mill operators along the entire life cycle – from planning and commissioning to maintenance and modernization.

Lechler offers the best qualifications for planning and installing new rolling mill cooling systems as well as for the overhaul of existing systems. The proof: over 500 installed SELECTOSPRAY roll cooling systems.



OUR COMMON GROUND: ROLLING FUNDAMENTALS

Because of the current demands on mills to process much lighter exit gages from increased incoming hot strip thickness, much larger reductions are necessary on individual mill stands. Such high reductions at a nominal width result in a larger area of contact with corresponding higher rolling force, friction and heat generation.

These high reduction rates, together with an increasingly wide range of cross-sections and materials, bring additional challenges for effective temperature management:

- Maximum heat extraction at minimal coolant consumption
- Symmetrical thermal profiles on the work rolls (minimum temperature gradient)
- Controlled thermal crowns
- No thermal differentials between top and bottom roll
- Ensure that the roll bending system is kept within the appropriate thermal crown height and symmetry

When it comes to producing steel or aluminum in hot, cold or foil rolling mills, optimizing shape and flatness is critical in order to create the best surface quality. To achieve this, you need an effective roll cooling process in place to reduce defects commonly known as quarter buckle, wavy edge, and full shape or center buckle.

Flatness deviations

Symmetrical flatness deviations can be controlled by mechanical mill actuators like roll bending, roll shifting and roll swiveling quite well. Asymmetric flatness deviations, like quarter buckles, however require the application of selective roll cooling.

Irregular elongation occurs during the primary cold reduction process and will diminish the overall quality of the rolled product. These defects can be broken down into several areas: wavy edge, full shape or center buckle, and quarter buckles.

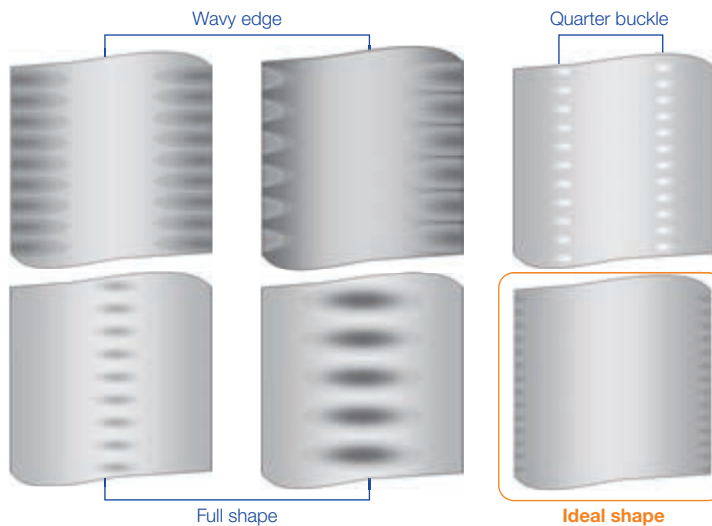

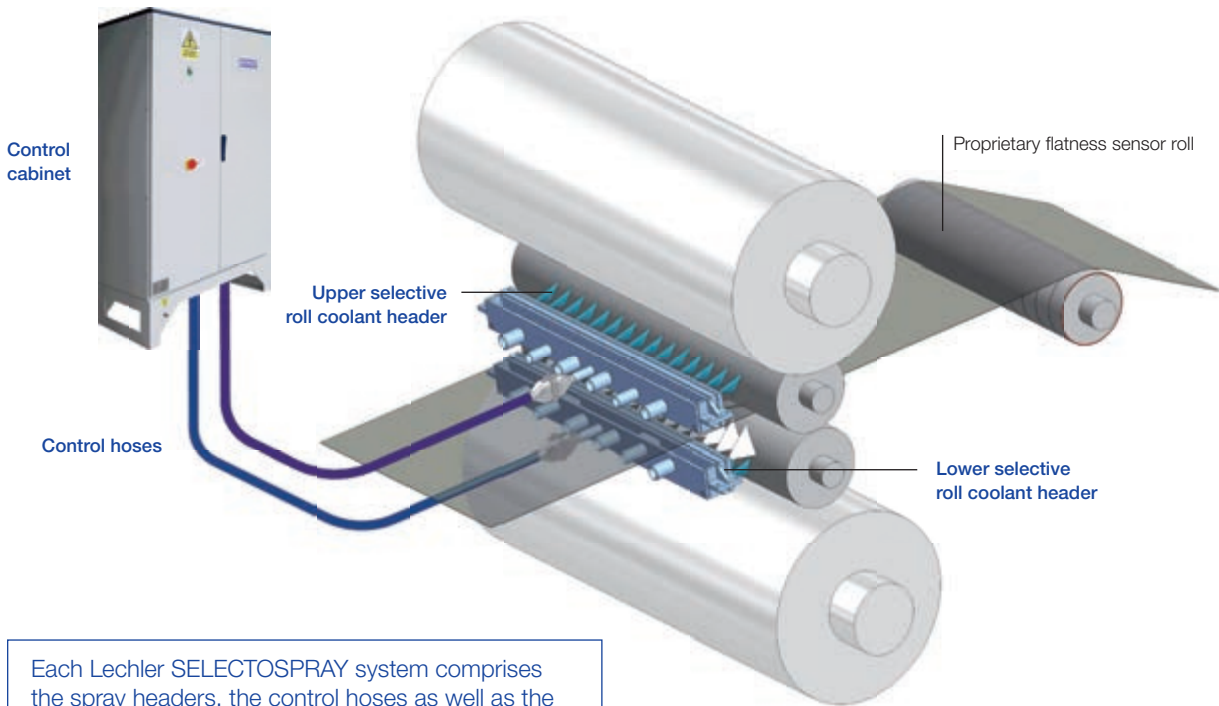

Each Lechler SELECTOSPRAY system comprises the spray headers, the control hoses as well as the associated control cabinet.

Shape and flatness of the strip is measured via the stress across the mills shape meter. The images below show the flatness measurement system, where full shape or center buckle could occur due to stress distribution being low in section B, and high stress in sections A and C.

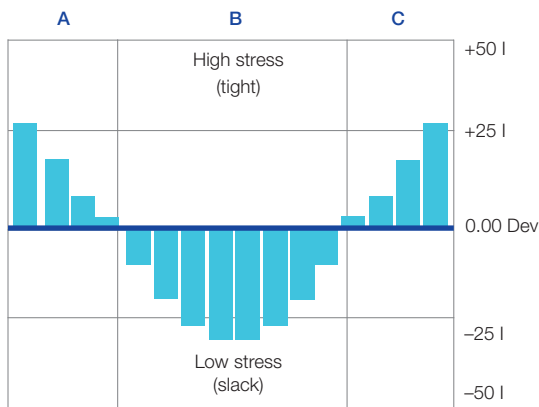

Radical force is converted to stress value in I Units

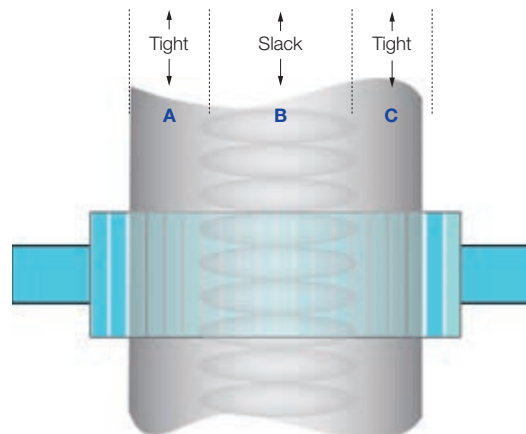

Zone B is longer than A and C

Automatic Flatness Control

Selective roll cooling is a proven measure to guarantee uniformly even surfaces of rolled products. It is applied equally in hot, cold and foil rolling mills. Automatic Flatness Control Systems (AFC) use measuring rolls to detect irregularities in the rolled product.

The SELECTOSPRAY roll cooling system as an integral part of the Automatic Flatness Control System (AFC) consists of the spray headers with valves and nozzles, the control cabinet and the interconnecting control hoses. The control cabinet is the interface to the external control system.



OUR COMMON GROUND: ROLLING FUNDAMENTALS

Hot sprays

Hot sprays are a special application especially for rolling of aluminum strip in cold rolling mills. In order to fight against so-called “tight edges”, the rolls are less cooled or even heated by the application of heated coolant typically up to 120 °C. The valves with nozzles are typically located on both header sides at small zonings of 26 mm.

Lubrication

In addition to cooling, the function of SELECTOSPRAY roll cooling systems is lubrication, i.e. the application of lubricant between the rolling stock and the rolls.

Control methods

There are various control philosophies. In many mills, the “basic and selective cooling” method is applied. Basic cooling/lubricating ensures that the rolls never run dry, while selective cooling influences profile and flatness. In that case, the “basic cooling” nozzles are activated according to the strip width being rolled, while the “selective nozzles” are activated in accordance to the flatness deviations.

Another method is the “pulsing mode”, where the control signals of the external control system determine the on/off time and hence the coolant volume. For that method, quick response times of valves are a must.

Pulse-width ratio 90 %

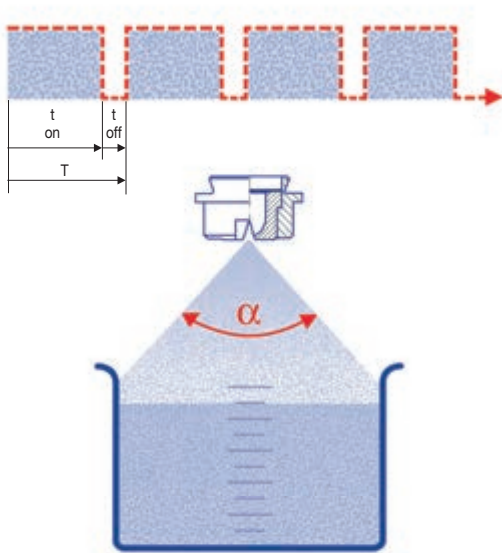

Pulse-width ratio 10 %

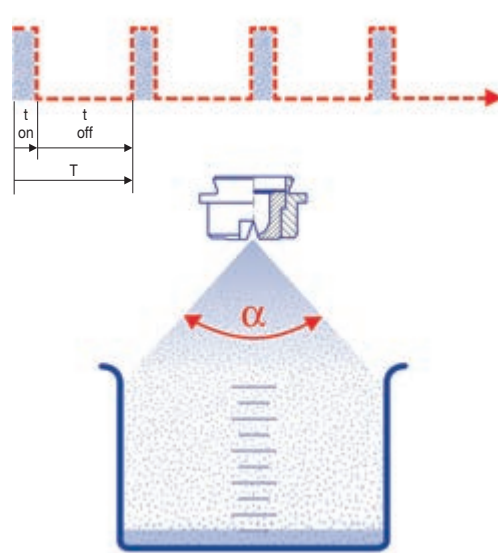



 SELECTOSPRAY
THE RIGHT CHOICE



TAILOR-MADE ROLL COOLING SYSTEMS

Thanks to the automations developed specifically for our SELECTOSPRAY systems, you benefit from more flexibility and adaptability to on-site requirements. Lechler offers control valves for the various application scenarios:

- pneumatic
- electropneumatic
- all electrical

Our systems meet the latest requirements of CE marking and cover all areas of LVD, EMC and panel IP/NEMA rating lime UL. They use Siemens S7 and many other PLC based systems. If you need a remote I/O system, we are happy to support you with our extensive experience with Profibus, TCP/IP, ABB Genius and other I/O platforms as well as hardwired systems.

Robust control hoses

We provide robust hose connections that can cope with the harsh environmental conditions in rolling mills at all times.

Outer hose design

- Outer steel braid over inner steel shell
- Stainless steel hose ends offering protection against high impact loads

Quick and easy connection

- Capable of being high pressure cleaned in place
- Self-aligning system to uncouple pneumatic/electrical connections for simple maintenance



SELECTOSPRAY headers

Lechler's industry experts have years of experience in the design, build, and operational process of our reliable roll cooling systems.

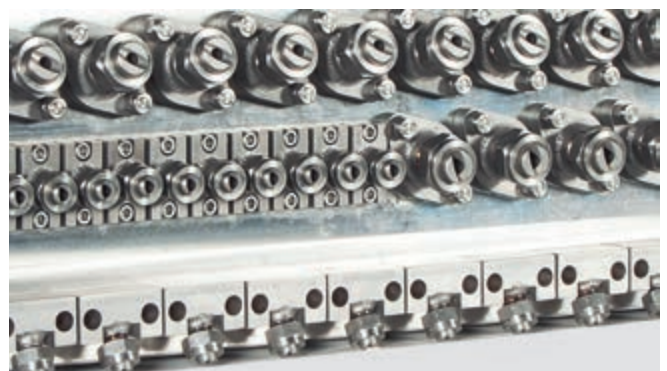

Headers are tailor-made for each mill. They are made of stainless steel to ensure maximum robustness in the harsh environment of the mill for many years.



SELECTOSPRAY THE RIGHT CHOICE

SELECTOSPRAY is a highly customizable system for selective roll cooling. Due to the different requirements on site, there can be no “one size fits all” valve solution. But there can be one that perfectly fits your rolling mill.

	Pneumatic valves		Electropneumatic	
				
Series	Modulax TS	Mini Modulax TS	Modulax DSA quick connect	Modulax DSA split design
Information on page	14	14	18	
Min. zoning 26 mm		•		
Failure-open	•	•	•	
Failure-close				
Use with water	•	•	•	
Use with emulsion	•	•	•	
Use with rolling oil	•	•	•	
Pulsing			•	
Hot sprays		•		
For steel hot mills	•		•	
For steel cold mills	•	•	•	
For aluminum hot mills	•	•	•	
For aluminum cold mills	•	•	•	
For non-ferrous mills		•		
Removable to header front	•	•	•	

valves		Electric valves	
			
Mini Modulax DSA quick connect	Mini Modulax DSA split design	EVA	Mini EVA
	18	22	22
	•		•
	•		
		•	•
	•	•	•
	•		
	•	•	•
	•		•
	•		
	•		
	•	•	•
	•		•
	•	•	•

SELECTOSPRAY pneumatic systems

Modulax TS and Mini Modulax TS

The Modulax TS (Twin Seal) valves are used in rolling mills where the ability to fail open is beneficial. This is applicable especially where emulsions or dispersions are used as coolants.

A fully pneumatic SELECTOSPRAY system requires no electrical equipment in the spray bars. All electrical components are housed protected in the control cabinet.

Polyamide tubes connect the solenoid valves in the control cabinet with the Modulax TS spray valves in the headers. Robust quick-release multiple air hoses with up to 44 single Polyamide tubes deliver the compressed air from the solenoid valves in the control cabinet to the spray valves in the headers. Each solenoid valve controls two spray valves for selective cooling in the same zone above and under the pass-line. The basic cooling/lubricating spray valves are controlled from the center outwards, while one solenoid valve operates up to four spray valves.

Operation

When pressurized air passes through the opened solenoid in the control cabinet, it acts on the rear of the piston, moving it forward closing the Modulax TS valve. When air pressure is removed by the closing of the solenoid in the remote cabinet, liquid pressure forces the piston back, opening the valve, and allowing the coolant to flow to the nozzle.

Cooling efficiency

Large inlet ports in the valve body permit coolant to enter directly and laminar to the nozzle. Due to the perfect shape inside the valve, the nozzle forms a perfect blade-like flat jet for optimized heat transfer.



Features Modulax TS and Mini Modulax TS:

- 2 : 1 coolant/air pressure ratio
- Four large coolant inlets for laminar flow
- Completely removable from the header front

Advantages:

- Efficient cooling by blade-shaped sprays
- Reduced downtimes due to easy maintenance
- Simple integration thanks to use of standard shop air

Benefits:

- No electrics in the mill – easy maintenance
- Contamination tolerant – can be used with emulsion
- Works with shop air – no extra compressor required



Modulax TS valve 52 mm/2"

The Modulax TS valve features a modular design for laminar flow in axial direction and has proven its value in reams of rolling mills all over the world. Thanks to only one moving part – the Delrin piston with twin lip seals – it is extremely easy to maintain.



Mini Modulax TS valve 26 mm/1"

The Mini Modulax TS valve is the little brother of the Modulax TS, and is used in rolling mills where space is restricted and where small zonings below 50 mm are required. The operating principle is the same as the Modulax TS.

Modulax TS flow data

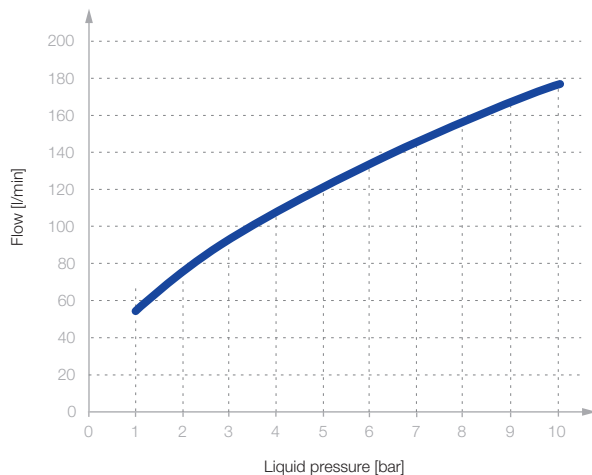

Mini Modulax TS flow data

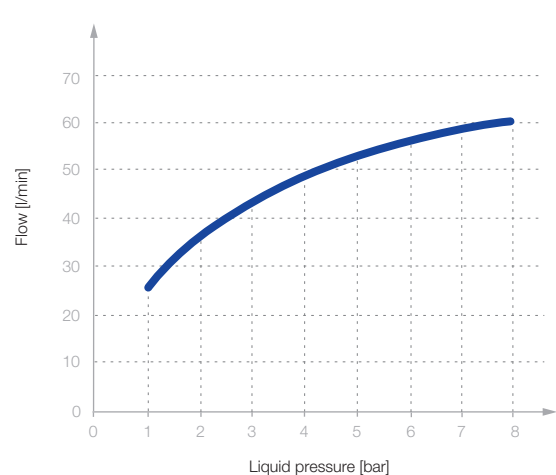

Maximum valve flow table (other flows are available with the correct Lechler nozzle selection)

SELECTOSPRAY pneumatic systems

Pneumatic control hoses

Our pneumatic control hoses connect any control panel with other apparatus and will provide control in difficult environments. With simple and easy to install fittings the connectors have keyed locations that make the task quick and a single person job.

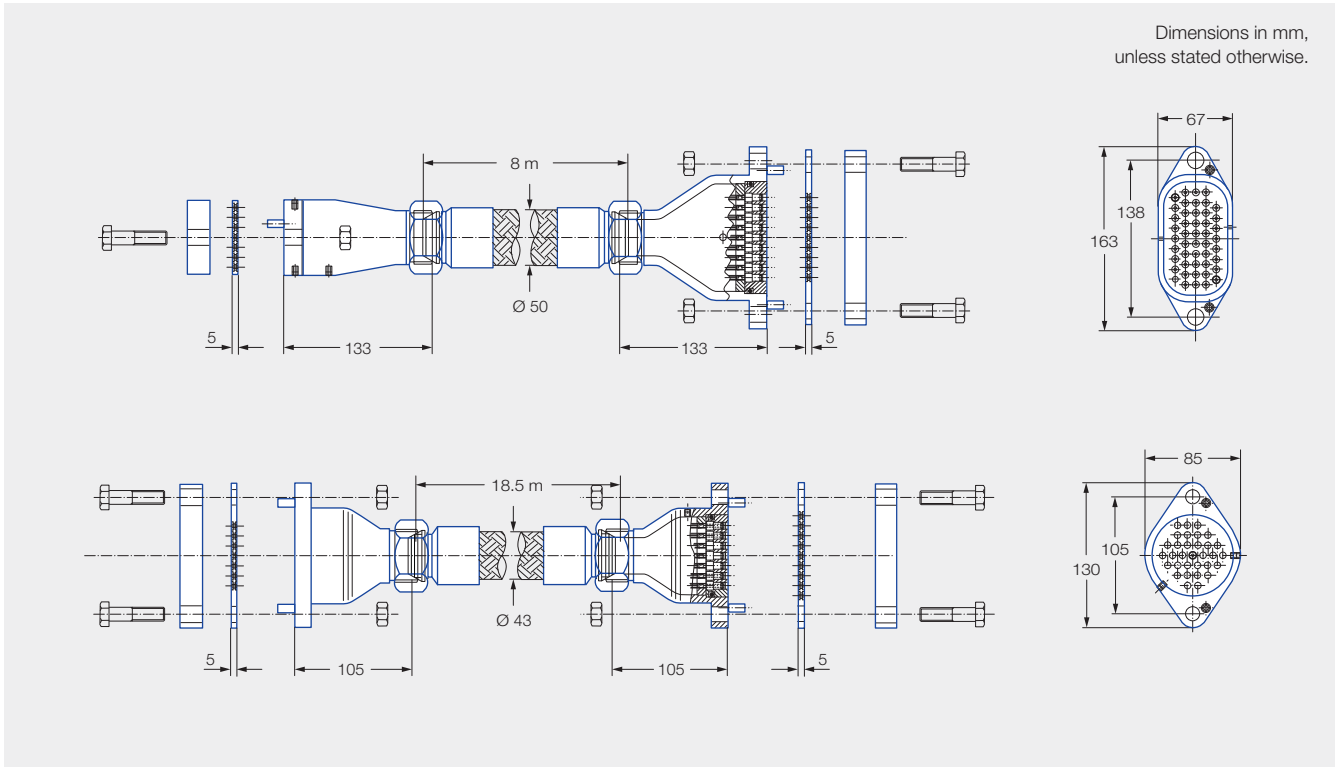

Pneumatic valves



Valves removable from the front of the header

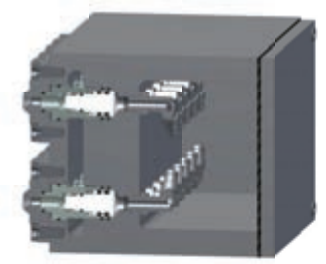
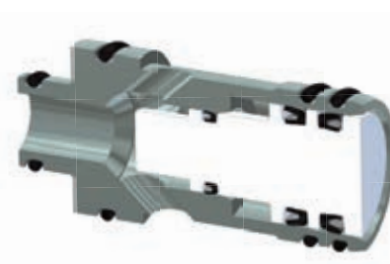
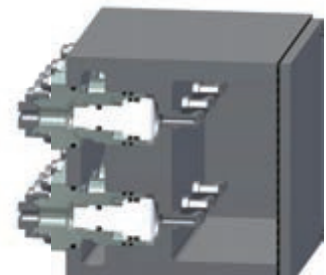
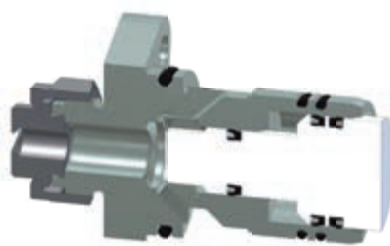

SELECTOSPRAY pneumatic systems

Spray headers and nozzles

The Lechler header design concepts ensure faster times to market and a more competitive pricing. By developing smaller valves that match the flow of traditional larger valve designs, we can provide more compact headers that make room for flatness optimization even in confined environments.

	Modulax TS	Mini Modulax TS
Use with control hose	Air hose	Air hose
Product code	961.MDX.00.00.00.0	961.000.00.MM.TS.0
Recommended horizontal pitch	52 mm (min 50 mm)	26 mm (min 25 mm)
Solenoid	Inside control cabinet	Inside control cabinet
Power consumption solenoid	1.7 W @ 24 VDC (other voltages available)	1.7 W @ 24 VDC (other voltages available)
Max flow	159 l/min @ 8 bar	59 l/min @ 8 bar
Response time	50 ms per meter of control hose length (typical)	50 ms per meter of control hose length (typical)
Pulse frequency	n. a.	n. a.
Coolant working pressure	Min. 3 bar, max 9 bar	Min. 3 bar, max 9 bar
Coolant filtration requirement	250 micron	250 micron
Coolant metal particle content	100 ppm	100 ppm
Coolant temperature	Max 120 deg C	Max 120 deg C
Air pressure	Min 5 bar, max 8 bar	Min 6 bar, max 8 bar
Air filtration	40 micron	40 micron
Dew point	2–5 deg C	2–5 deg C
Header dimensions approx. (width by depth)	170 x 165 mm (2 rows) 215 x 165 mm (3 rows)	120 x 100 mm (2 rows) 160 x 100 mm (3 rows)
Materials Nozzle and valve housing	Stainless steel	Stainless steel
Materials Piston	Delrin (POM)	Delrin (POM)
Materials Seals	Viton	Viton
Materials Air tube	Nylon (Polyamide)	Nylon (Polyamide)

SELECTOSPRAY electropneumatic systems

Modulax DSA and Mini Modulax DSA

The Modulax DSA (Direct Solenoid Actuation) valves offer all the benefits of the Modulax TS valves, with the enhanced feature of an integrated solenoid actuator. It is used in rolling mills where pulsing mode and the ability to fail open is beneficial. Typically, where emulsions or dispersions are used as the coolant.

The solenoid valves are integral parts of the DSA valves in the spray header. Consequently, the spray headers are equipped with air pressure feeds to serve the solenoid valves. Robust quick-connect multicore control cable hoses with up to 108 single cables deliver the control signals from the cabinet to the spray headers.

Operation

The discreet solenoid actuator allows to be pulsed up to 5 Hz. If a front coolant seal fails due to mechanical damage, the secondary seal becomes energized, forcing the piston back and preventing any coolant from flowing through the solenoid into the rear chamber, ensuring improved integrity. In the event of a seal failure, the Modulax DSA indicates a problem by releasing coolant through the front vent.

Cooling efficiency

Both electropneumatic valve types feature large inlet ports that permit coolant to enter directly and laminar to the nozzle. Due to the perfect shape inside the valve, the nozzle forms a perfect blade-like flat jet for optimized heat transfer.



Features Modulax DSA and Mini Modulax DSA:

- 2 : 1 coolant/air pressure ratio
- Four large coolant inlets
- Only one moving part, the low inertia Delrin piston assembly
- Electropneumatic actuation
- Can be fitted with nozzle blocks or the self-aligning dovetail fixing of the SELECTOSPRAY nozzle range
- Easily, completely removable from the front of the header
- Solenoid valves located directly behind the valve

Advantages:

- Long-life low-friction lip seals
- Tested to over 20 million cycles
- Header solenoid protection
- Visible seal damage indicator
- Cost effective replacement
- Segregation of air and coolant by a secondary protection barrier seal

Benefits:

- Fast response time – ready for pulsing mode
- Contamination tolerant – can be used with emulsion
- Works with shop air – no extra compressor needed



Modulax DSA valve 52 mm/2"

The Modulax DSA valve is based on the Modulax TS valve, but has the actuating solenoid valve directly attached.



Mini Modulax DSA valve 26 mm/1"

The Mini Modulax DSA valves are the little brothers of the Modulax DSA valves. They are used in rolling mills where pulsing mode is required, space is restricted, and where small zonings below 50 mm are required. The operating principle is the same as the Modulax DSA.

Modulax DSA flow data

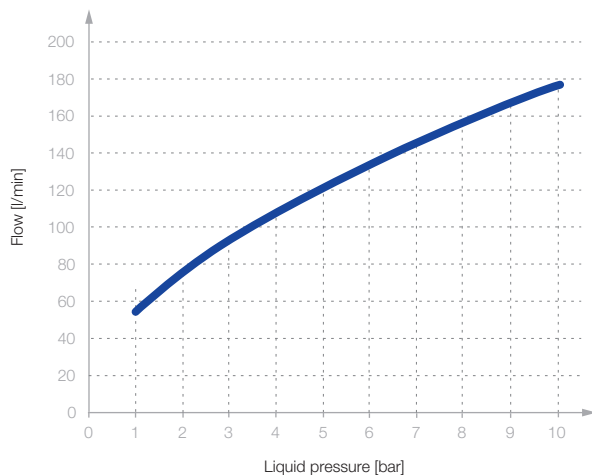

Mini Modulax DSA flow data

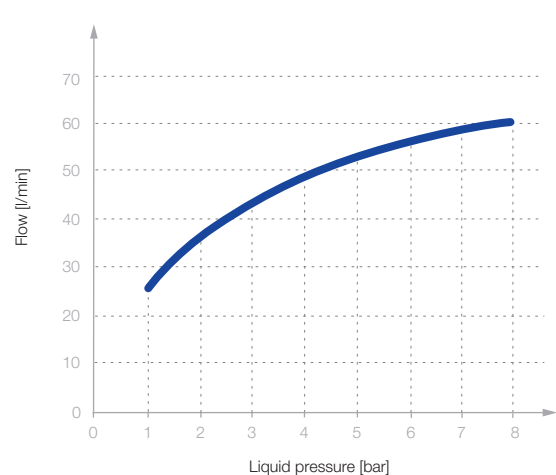

Maximum valve flow table (other flows are available with the correct Lechler nozzle selection)

SELECTOSPRAY electropneumatic systems

Electrical control hoses

Our electrical control hoses contain up to 108 single cables. Fitted with standard couplings on the cabinet side and extra robust couplings on the header side, convoluted stainless steel hoses and stainless steel braiding, they withstand the harsh conditions in rolling mills.

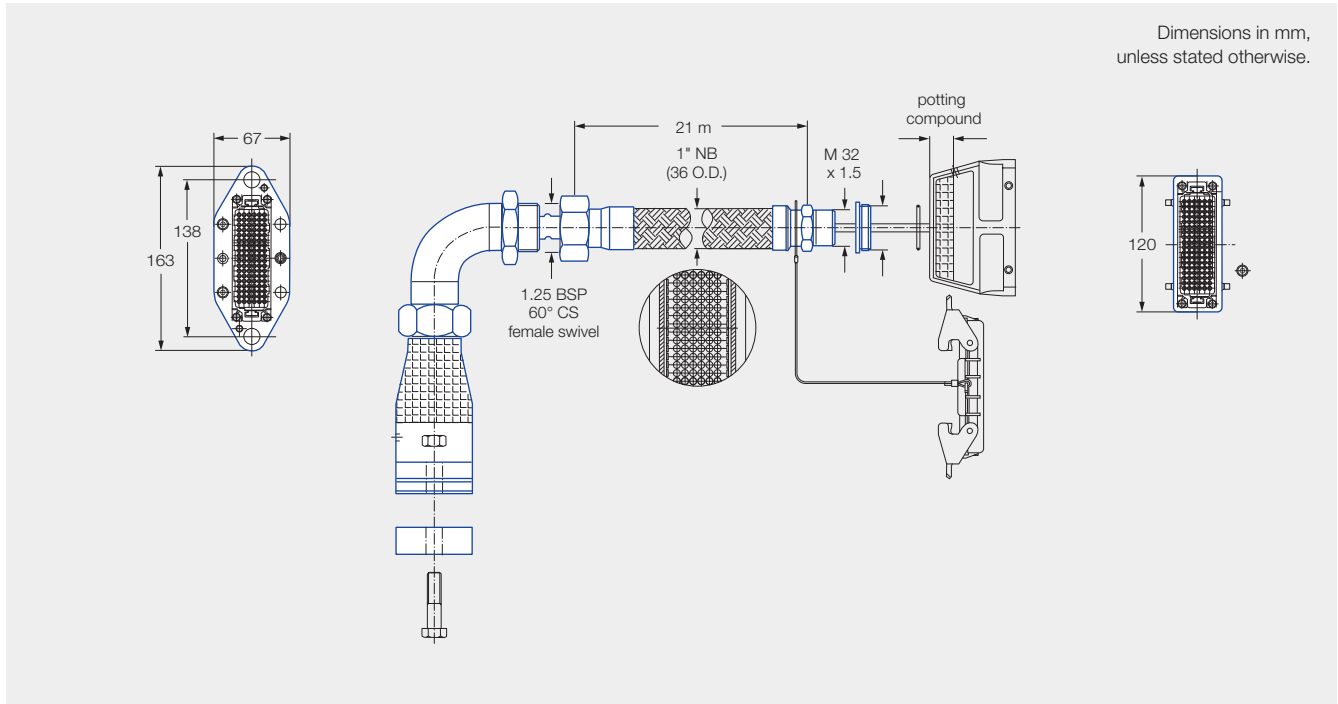

Electropneumatic valves



Valves removable from the front of the header

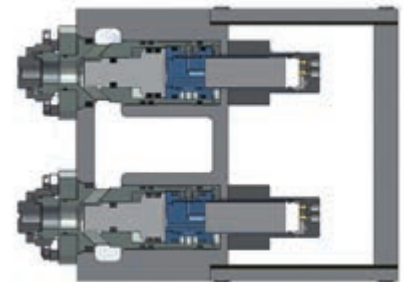
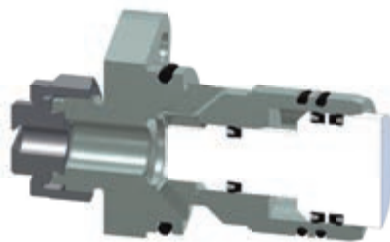

Modulax DSA quick connect

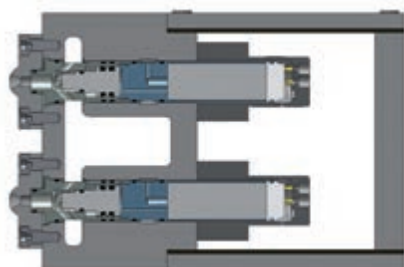
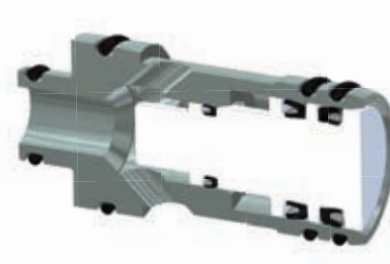

Mini Modulax DSA quick connect

SELECTOSPRAY electropneumatic systems

Spray headers and nozzles

The Lechler header design concepts ensure faster times to market and a more competitive pricing. By developing smaller valves that match the flow of traditional larger valve designs we can provide more compact headers that make room for flatness optimization even in confined environments.

	Modulax DSA	Mini Modulax DSA
Use with control hose	Cable hose	Cable hose
Product code	961.DSA.00.QC.00.0 961.DSA.00.SP.00.0	961.DSA.MM.QC.00.0 961.DSA.MM.SP.00.0
Recommended horizontal pitch	52 mm (min 50 mm)	26 mm (min 25 mm)
Solenoid	Inside header	Inside header
Power consumption solenoid	1.5 W @ 24 VDC (NC)	1.5 W @ 24 VDC (NC)
Max flow	159 l/min @ 8 bar	59 l/min @ 8 bar
Response time	30 ms @ coolant pressure 6.5 bar, air pressure 5 bar	30 ms @ coolant pressure 6.5 bar, air pressure 5 bar
Pulse frequency	5 Hz	5 Hz
Coolant working pressure	Min. 3 bar, max 9 bar	Min. 3 bar, max 9 bar
Coolant filtration requirement	250 micron	250 micron
Coolant metal particle content	100 ppm	100 ppm
Coolant temperature	Max 90 deg C	Max 90 deg C
Air pressure	Min 6 bar, max 8 bar	Min 6 bar, max 8 bar
Air filtration	40 micron	40 micron
Dew point	2–5 deg C	2–5 deg C
Header dimensions approx. (width by depth)	200 x 220 mm (2 rows)	125 x 210 mm (2 rows)
Materials Nozzle and valve housing	Stainless steel	Stainless steel
Materials Piston	Delrin (POM)	Delrin (POM)
Materials Seals	Viton	Viton
Materials Air tube	Nylon (Polyamide)	Nylon (Polyamide)

SELECTOSPRAY electric systems

EVA and Mini EVA

The Lecher EVA (Electric Valve Actuation) is used in rolling mills where inflammable rolling oil, kerosene or water is used as a coolant.

In the event of a malfunction, the Lechler EVA stops the flow of the flammable coolant and prevents the risk of a major fire. Because it does not require compressed air to operate, it fulfills all the demands, both functional and commercial, of a modern rolling facility.

Operation

EVA and Mini EVA valves both work on the same principle. Electrical control signals 24 V control an internal pilot valve. As soon as it is opened, the pressurized coolant activates the piston and exits through the nozzle. The valves do not require compressed air to operate.

Cooling efficiency

Large inlet ports permit coolant to enter directly and laminar to the nozzle. Due to the perfect shape inside the valve, the nozzle forms a perfect blade-like spray for optimized heat transfer.



Features EVA and Mini EVA:

- Completely cable free
- Self-aligning, ensuring a perfect connection every time
- Class leading flow capability
- Pulse rate up to 5 Hz
- Operating typically at 52 mm centers (50 mm optional).
52/50 mm centers = EVA
26/25 mm centers = Mini EVA
- Stainless steel construction
- Long life and easy to maintain
- Can be fitted with nozzle blocks or the Lechler SELECTOSPRAY nozzle range

Advantages:

- No control air required
- Large orifices for a laminar flow and a stable spray pattern, providing effective and precise roll cooling
- Easily and completely removable from the front of the header
- No requirement to remove the header from the mill window

Benefits:

- Fast response time – capable for pulsing mode
- Failure close – suitable for inflammable coolants
- Temperature range up to 120 deg C – suitable for hot sprays

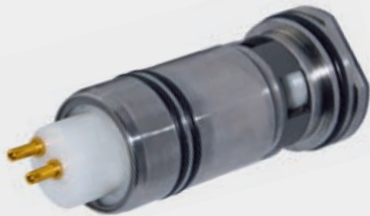

EVA quick connect 52 mm/2" with offset pins

The EVA valve is used in rolling mills where inflammable rolling oil or kerosene is used as a coolant. In applications such as aluminum cold or foil mills, there is the demand for valves that have the built-in function to fail closed. In the event of a mill fire, the risk of prolonging the hazard is reduced. The EVA valve does not require compressed air to operate.



Mini EVA quick connect 26 mm/1" with offset pins

The Mini EVA valve encompasses the same design principles as the 52 mm EVA valve with the built-in function to fail closed. The Mini EVA has a class leading flow rate for a 26 mm envelope. This enables Lechler engineers to design low aspect roll cooling headers allowing the optimum positioning of the header inside the mill window.

EVA flow data

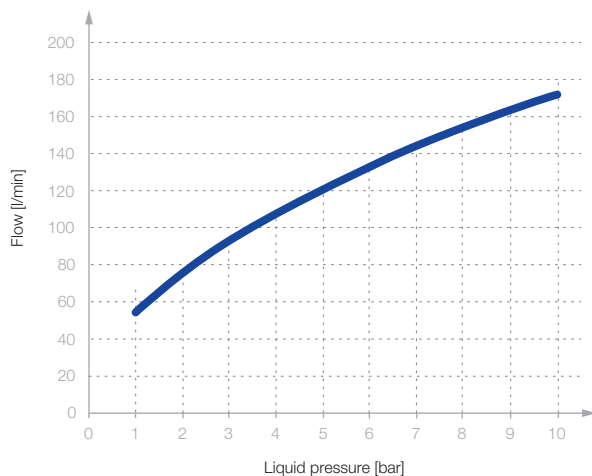

Mini EVA flow data

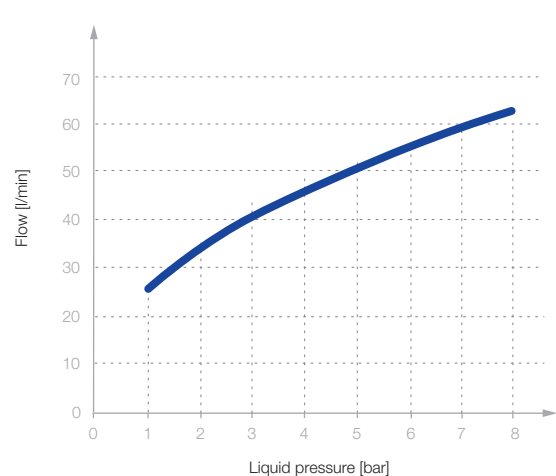

Maximum valve flow table (other flows are available with the correct Lechler nozzle selection)

SELECTOSPRAY electric systems

Electrical control hoses

The cables provide connections between the control cabinet and other devices in an environment that is challenging for electrical signals. The internal PTFE coating of the cables ensures long-term connectivity.

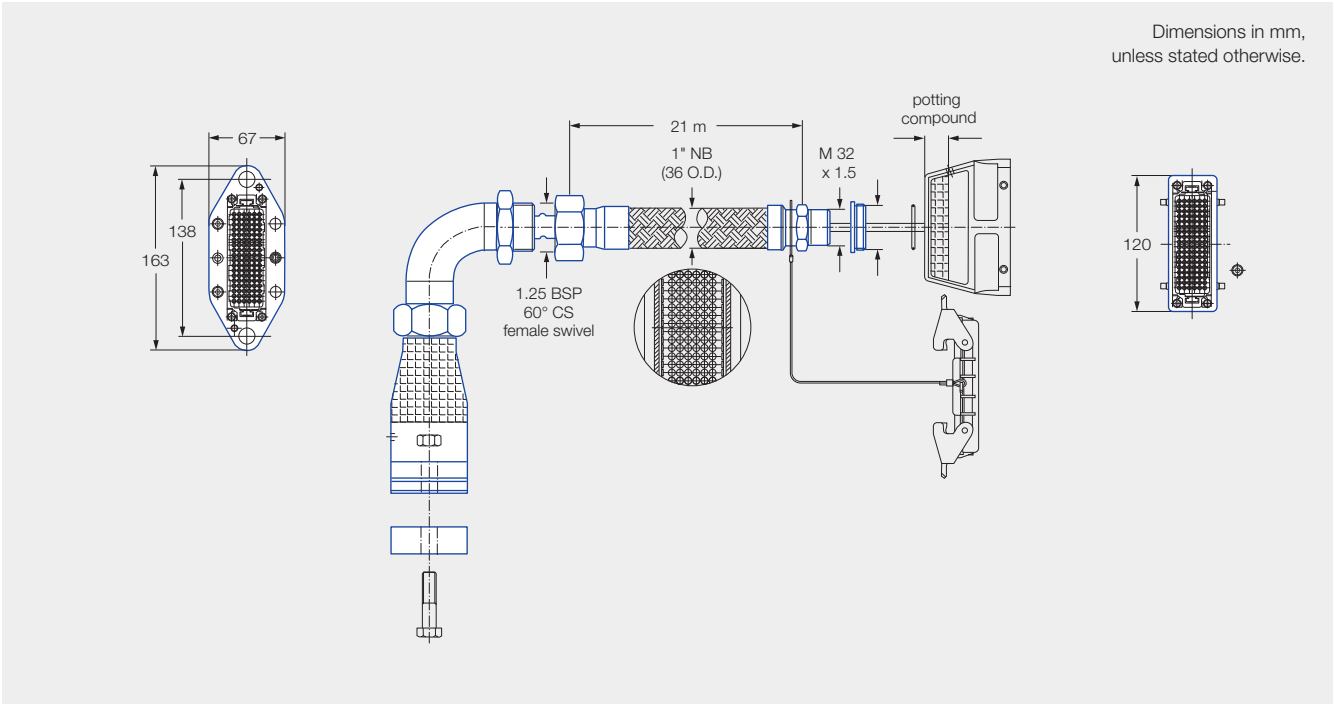

Electric valves



Totally serviceable from the header front

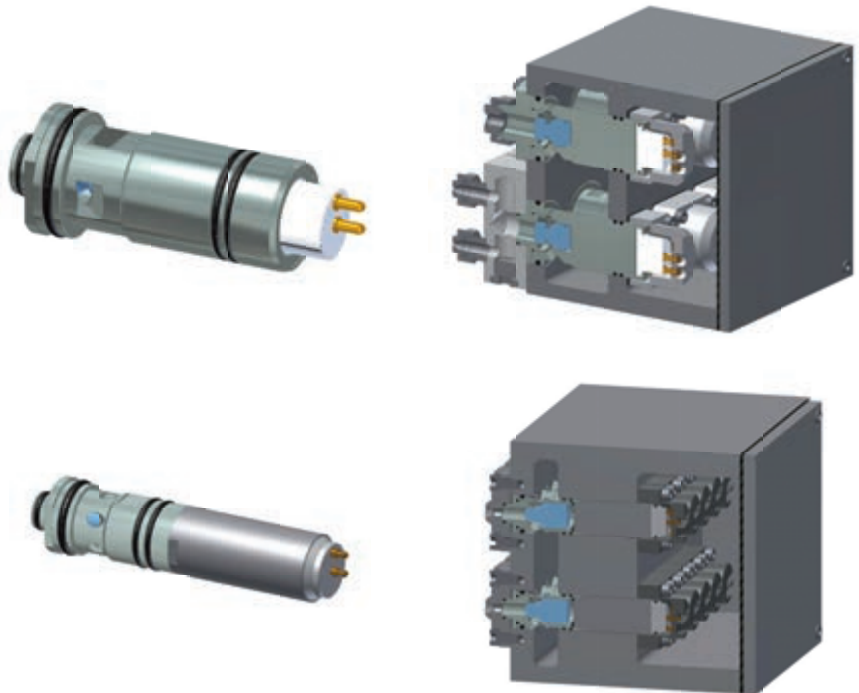



SELECTOSPRAY electric systems

Spray headers and nozzles

The Lechler header design concepts ensure faster times to market and a more competitive pricing. By developing smaller valves that match the flow of traditional larger valve designs we can provide more compact headers that make room for flatness optimization even in confined environments.

	EVA	Mini EVA
Use with control hose	Cable hose	Cable hose
Product code	961.EVA.CS.QC.OP.0	961.EVA.MM.QC.00.0
Recommended horizontal pitch	52 mm (min 50 mm)	26 mm (min 25 mm)
Solenoid	Inside header	Inside header
Power consumption solenoid	9.7 W @ 24 VDC	10.2 W @ 24 VDC
Max flow	159 l/min @ 8 bar	59 l/min @ 8 bar
Response time	30 ms @ coolant pressure 6.5 bar	30 ms @ coolant pressure 6.5 bar
Pulse frequency	5 Hz	5 Hz
Coolant working pressure	Min. 3 bar, max 9 bar	Min. 3 bar, max 9 bar
Coolant filtration requirement	25 micron	25 micron
Coolant metal particle content	100 ppm	100 ppm
Coolant temperature	Max 120 deg C	Max 120 deg C
Air pressure	n. a.	n. a.
Air filtration	n. a.	n. a.
Dew point	n. a.	n. a..
Header dimensions approx. (width by depth)	185 x 180 mm (2 rows) 280 x 180 mm (3 rows)	135 x 150 mm (2 rows) @ 52 mm pitch 195 x 150 mm (3 rows)
Materials Nozzle and valve housing	Stainless steel	Stainless steel
Materials Piston	Delrin (POM)	Delrin (POM)
Materials Seals	Viton	Viton
Materials Air tube	n. a.	n. a.



SERVICES

WE KEEP YOUR BUSINESS ROLLING

Every rolling plant has its own priorities and not every maintenance measure is necessary in every case. That's why our services come as part of a modular kit from which you can choose the maintenance you really need.



Planning

We support you in the planning and design of cooling and lubrication systems in new rolling mills. In doing so, we take your individual requirements into account and simulate subsequent operation in all details. After the digital model shows everything working exactly as desired, we integrate your tailor-made SELECTOSPRAY system into the plant.

Revolving off-site header and hose refurbishment

On-site repair or preventive maintenance of all valves may require a mill shutdown longer than desirable. Therefore, Lechler has introduced the system of revolving headers.

With one spare header of each type, optimally-refurbished headers are operational in the mill in trouble-free conditions while the additional header is being serviced at Lechler. After a defined operation period, the headers will be changed again. The same can be done for control hoses. Prior to the refurbishment, a repair report together with a quotation is sent to the customer for approval.

Inspection

During a mill shutdown, our experts carry out a visual assessment together with mechanical, pneumatical and electrical function and spray tests of the selective roll cooling system. Our findings will be summarized in a comprehensive report including results and recommendations.

Off-site refurbishment

Sometimes spray headers, control hoses and control cabinets experience damage or wear which require maintenance beyond an on-site repair job. In those cases, the equipment can be brought back to the Lechler service center for repair and refurbishment.

Consulting and maintenance

Our experts provide operation and troubleshooting training on site. Consulting regarding the optimal application of the coolant in other mill stands for process improvements can also be given.

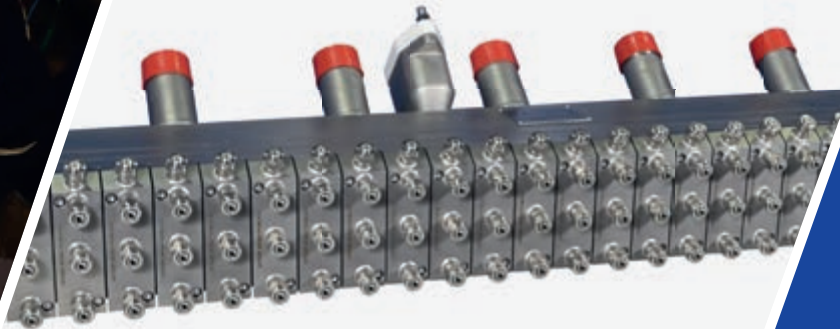

Preventive maintenance

Our experts carry out regular and scheduled visual assessments and functional tests. They replace typical wear parts and repair or change any faulty or worn component. Yearly maintenance contracts are the basis for such cooperation and offer you maximum cost transparency.

Unscheduled repair

If need be, we carry out necessary repairs during a mill shutdown provided that the required spare parts are available on site.



**ENGINEERING
YOUR SPRAY SOLUTION**



Lechler GmbH · Precision Nozzles · Nozzle Systems

Ulmer Strasse 128 · 72555 Metzingen, Germany · Phone +49 7123 962-0 · info@lechler.de · www.lechler.com

ASEAN: Lechler Spray Technology Sdn. Bhd. · 22, Jln. Astaka 4B/KU2 · Bdr. Bukit Raja · 41050 Klang · Malaysia · Phone +603 3359 1118 · info@lechler.com.my

Belgium: Lechler S.A./N.V. · Avenue Newton 4 · 1300 Wavre · Phone +32 10 225022 · info@lechler.be

China: Lechler Nozzle Systems (Changzhou) Co., Ltd. · No.99 Decheng Rd, Jintan, Changzhou, JS 213200, P.R.C · Phone +86 400-004-1879 · info@lechler.com.cn

Finland: Lechler Oy · Ansatie 6 a C 3 krs · 01740 Vantaa · Phone +358 207 856880 · info@lechler.fi

France: Lechler France SAS · Parc de la Haute Maison · 6, Allée Képler, Bâtiment C2 · 77420 Champs-sur-Marne · Phone +33 1 49882600 · info@lechler.fr

Great Britain: Lechler Ltd. · 1 Fell Street, Newhall · Sheffield, S9 2TP · Phone +44 114 2492020 · info@lechler.com

India: Lechler (India) Pvt. Ltd. · Plot B-2 · Main Road · Wagle Industrial Estate Thane · 400604 Maharashtra · Phone +91 22 40634444 · lechler@lechlerindia.com

Italy: Lechler Spray Technology S.r.l. · Via Don Dossetti, 2 · 20074 Carpiano (Mi) · Phone +39 02 98859027 · info@lechleritalia.com

Spain: Lechler, S.A. · C / Isla de Hierro, 7 – Oficina 1.3 · 28703 San Sebastián de los Reyes (Madrid) · Phone +34 91 6586346 · info@lechler.es

Sweden: Lechler AB · Håvertgatan 29 · 254 42 Helsingborg · Phone +46 18 167030 · info@lechler.se

USA: Lechler Inc. · 445 Kautz Road · St. Charles, IL 60174 · Phone +1 630 3776611 · info@lechlerusa.com