

**ENGINEERING
YOUR SPRAY SOLUTION**

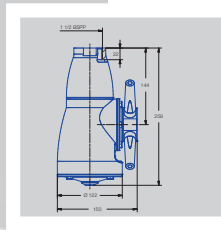

Installation and Operating Manual for Tank and Equip- ment Cleaning Nozzles

Series 5TM

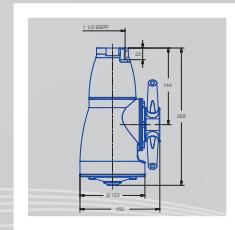
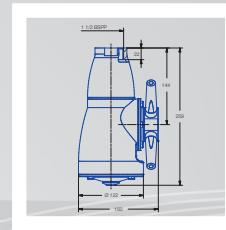
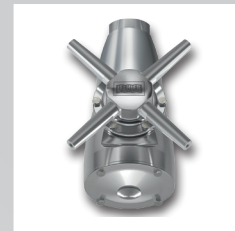
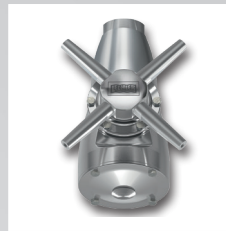

Installation and Operating Manual

This instruction manual contains proprietary information which is protected by copyright laws.

No part of this document may be copied or transmitted for any purposes in any form either electronically or mechanically without prior written authorization.

Lechler GmbH is not liable for damages resulting from using components or spare parts which are not original parts of Lechler GmbH.

All other brands or brand names which are not mentioned here can be trademarks or registered trademarks and need to be treated accordingly.

© Lechler GmbH,
Ulmer Straße 128,
72555 Metzingen/Germany

All rights reserved.

CONTENT		Page
1	Scope	3
2	Intended use	3
3	General	3
4	Explanation of symbols	3
5	Disposal	3
6	Foreseeable misuse	3
7	Marking	3
8	Delivery scope	3
9	Delivery inspection	4
10	Safety	4
10.1	General information	4
10.2	Operating personnel	4
10.2.1	Requirements	4
10.2.2	Instruction and training assistance	4
10.3	Personal protective equipment	4
10.4	Safety instructions	4
10.4.1	Surrounding	4
10.4.2	Special risks	5
11	Installation	5
11.1	Preparation	5
11.2	Installation of the threaded connection	5
11.3	Checks	5
12	Start-up	5
13	Frost protection	6
14	Maintenance	6
14.1	General	6
15	Quality assurance	6
16	Technical data	7

1. Scope

This instruction manual is intended for people who are commissioned with the installation and operation of the device.

For more information, please contact

Lechler GmbH
Ulmer Straße 128
72555 Metzingen / Germany
Tel. +49 (0)7123 962 – 0
Fax +49 (0)7123 962 – 444
www.lechler.de

2. Intended use

Lechler tank and equipment cleaning nozzles are hydraulically driven components which are used in tanks and equipment for cleaning and rinsing. Other applications are not intended and are not permitted.

3. General

In the following term “rotating cleaning nozzle” is used instead of “Lechler tank and equipment cleaning nozzle”.

4. Explanation of symbols

Warnings are indicated by symbols. The instructions are preceded by signal words which express the degree of risk. Follow the instructions and act cautiously in order to avoid accidents, personal injury and property damage.



DANGER!

indicates an imminently hazardous situation resulting in death or serious injury if not avoided.



WARNING!

indicates a potentially hazardous situation which could result in death or serious injury if not avoided.



CAUTION!

indicates a potentially hazardous situation which could result in minor injuries if not avoided.



CAUTION!

indicates a potentially hazardous situation which could result in property damage if not avoided.



NOTE!

provides useful tips and recommendations as well as information for efficient and trouble-free operation.

5. Disposal

The machine must be disposed of properly according to the national requirements and laws.



CAUTION! Environmental damage from chemical cleaning agents! If chemical agents are added it must be ensured that these do not reach the ground, water or the sewer system.

In Conclusion:

- Always collect chemical cleaning agents in suitable containers.
- Dispose of chemical cleaning agents properly.

6. Foreseeable misuse

- Any use other than defined in the section “Intended use” without written approval of the manufacturer.
- Operation beyond the technical application limits.
- Unauthorized modifications or conversions, as well as manipulation of the machine.
- Work executed by non-qualified personnel.
- Using unsuitable or incompatible materials, auxiliary materials, operating materials or accessories.
- Non-compliance with safety and operating instructions, and health and safety accident prevention regulations or legal regulations.
- Using spare parts and accessories other than originals, which are not equivalent in quality and function.

7. Marking

Symbols and signs are located in the working area. They refer to the immediate surrounding of the machine on which they are displayed.



WARNING! Risk of injury through illegible signs!

In the course of time labels and symbols on the machine can get dirty or illegible in a different manner.

In conclusion:

- Always keep safety, warning and operating instructions in legible condition on the machine.
- Replace damaged signs or labels immediately.

8. Delivery scope

One piece of the high impact tank cleaning machine “IntenseClean” series 5TM.



NOTE!

If one series contains different types, please refer to the details on the shipping documents.

9. Delivery inspection

Check the delivery immediately on receipt for thoroughness and shipping damages.

Proceed as follows in the case of detectable external shipping damages:

- Do not accept delivery.
- Record the extent of damage on the shipping documents or on the shipper's delivery note.
- File a complaint.



NOTE!

File a complaint regarding every issue as soon as it is detected. Damage claims can only be filed within the valid claims periods.

10. Safety

10.1 General information

Here is an overview of all important safety aspects for optimum protection of personnel as well as for safe and problem-free operation.

Failure to follow the guidelines listed in these instructions can result in significant hazards.

In addition to the information in these operating instructions, the general applicable safety and accident prevention regulations must be observed!

10.2 Operating personnel

10.2.1 Requirements



WARNING! Risk of injury due to insufficient qualifications. Improper handling can result in serious personal injury and property damage.

In conclusion:

- only allow special actions to be carried out by appointed authorized persons.
- When in doubt, consult experts.

In the operating instructions the following qualifications are specified for various activities:

- An instructed person has been informed by the operator of their assigned tasks and the possible dangers related to improper behavior.
- A specialist due to their focused training, knowledge and experience, as well as an awareness of the relevant regulations, is in a position to carry out the work assigned to them while recognizing potential hazards by themselves.

10.2.2 Instruction and training assistance

The operator is required to inform and provide training for operating personnel with regard to existing laws and accident prevention regulations. The various professional qualifications of employees are taken into account for this.

10.3 Personal protective equipment

Personal protective equipment helps to prevent people from compromising safety and health at work.



WARNING! There is a risk of injury from lack of protective clothing! The lack of protective clothing while working with hazardous and harmful liquids can result in serious personal injury and damage to property.

In conclusion:

- Always wear the necessary protective clothing for the task while working.
- Follow the instructions on the safety data sheet of the liquid.

For all primary work wear:



Protective work wear

includes work clothes with tight fitting and durable protection against airborne objects.



Safety shoes

to protect against heavy falling parts and slipping on slippery surfaces.



Face mask

to protect the eyes and face from fine particles.



Hearing protection

to protect against hearing impairments.

10.4 Safety instructions

Observe the safety notes listed here and warning notes in the following chapters of this instruction manual to reduce health hazards and to avoid dangerous situations.

10.4.1 Surrounding

The rotating cleaning nozzle may only be used in enclosed tanks or spaces. Only authorized personnel may stay in the area of operations.

10.4.2 Special risks



WARNING! Risk of injury through unauthorized substitutions! Using incorrect or defective spare parts can lead to danger to personnel as well as damage, malfunction or total failure.

In conclusion:

- Use original spare parts only.



WARNING! Danger to life, risk of injury or property damage through use of chemical cleaning agents! Using hazardous chemical cleaning agents can cause serious injuries.

In conclusion:

- Always note the safety data sheet of the cleaning agent.



WARNING! Risk of injury through hands being trapped! Hands can be trapped while working.

In conclusion:

- Keep sufficient distance between the nozzle and the device body.



WARNING! Hearing damage caused by noise! The noise level occurring in the working area can cause serious hearing damage.

In conclusion:

- Always wear hearing protection while working.
- Only stay in the danger zone when necessary.

11. Installation



CAUTION! Select hoses and pipes which meet the requirements regarding pressure, chemical and mechanical stress.

11.1 Preparation

Clean the working environment and remove dirt, grease and oil.

11.2 Installation of the threaded connection

Apply two applications of PTFE sealing tape or another suitable sealing material around the male pipe thread. Apply in clockwise direction. Screw the rotating cleaning nozzle onto the pipe.

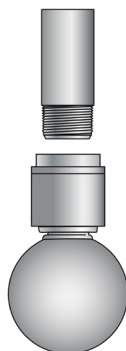

NOTE!

Use a suitable wrench to tighten the rotating nozzle so that the connection is tight and leak proof.



NOTE!

Make sure that the rotating cleaning nozzle cannot become detached.



NOTE!

Make sure that you don't damage the rotating cleaning nozzle during the installation.



NOTE!

Vibrations within the machine can cause automatic loosening of the thread. Therefore, secure the rotating cleaning nozzles by appropriate means.

11.3 Checks

Conduct the following checks before every use:

Check that all existing connections of the machine are firmly seated and secured.

Check hoses and pipes for damage

Observe the safety data sheet of the manufacturers if chemical additives are used.

12. Start-up

1. Vent the supply line before start-up

2. The suitability of the rotating cleaning nozzle regarding chemical resistance has to be checked before start-up.

3. The supply line should be flushed before start-up in order to avoid that dirt is washed into the rotating cleaning nozzle.



NOTE!

Do not open hand-operated valves abruptly in order to avoid pressure shocks.

4. To ensure efficient cleaning, all Lechler rotating cleaning nozzles should be used at the recommended operating pressure. (The annex contains data about the pressure)

5. The maximum operating pressure must not be exceeded in any case.

6. The maximum temperature must not be exceeded. (The annex contains data about the temperature)

7. Ensure to use a line strainer with the recommended mesh size. (The annex contains data about the filtration)

8. Clean the rotating cleaning nozzle before installation if it is used for the food and beverage industry.

9. Lechler rotating cleaning nozzles should be operated with compressed air only for short-term usage. Operation with compressed air leads to premature wear of the bearing.
10. Only static spray balls are suitable for long-term operation with compressed air.

Only static spray balls are suitable for long-term operation with compressed air.

13. Frost protection

If the cleaning system is not continuously in use, it is necessary to ensure that the water in the rotating cleaning nozzle does not freeze during down time.

The connecting lines of the rotating cleaning nozzle must be uninstalled and emptied if necessary.

14. Maintenance

14.1 General



NOTE!

During maintenance measures the machine must be switched to off mode and pressure-free state, if necessary.



NOTE!

Use the original spare parts recommended by the manufacturer only.

■ Visual Inspection

1. Check the device for externally visible damages.

■ Blockage

1. Depressurize the system.
2. Disconnect the rotating cleaning nozzle.
3. Remove soiling of the rotating cleaning nozzle by flushing with water. Alternatively you can use compressed air.

■ Limescale

1. Examine if the tank cleaning nozzle is turning correctly.
2. If it is turning sluggishly, limescale on the ball bearing can be the reason.
3. Disconnect the rotating cleaning nozzle and treat it with a commercial limescale remover.



NOTE!

Please follow the instructions of the respective limescale remover.

4. Examine again whether the tank cleaning nozzle is turning correctly. If the tank cleaning nozzle still does not turn easily, it must be replaced.
5. We recommend maintenance after 500 hours of operation. The maintenance interval depends heavily on the opera-

ting conditions. In conclusion, the following applies: higher pressures, higher temperatures and dirty cleaning medium leads to premature wear. This series can be maintained by a Lechler service point or by the operator. You can find more information under: www.lechler.com/service-offers

15. Quality assurance

We take quality in design, production, assembly, final inspection and control seriously. It is essential for the permanently efficient and high-quality production of our products.

In order to guarantee our high-quality standards, we use a computer-assisted quality assurance system which we have applied for certification according to ISO 9001.

16. Technical data

High impact tank cleaning machine „IntenseClean“ series 5TM

Material
Stainless steel 316L SS, Stainless steel 304 SS, Stainless steel 302 SS, PTFE, PEEK

Max. temperature
95° C

Recommended operating pressure
5 bar

Installation
Operation in every direction is possible

Filtration
Line strainer with a mesh size of 0.2 mm/80 Mesh

Bearing
Ball bearing

Bearing
Ball bearing

Rotation monitoring sensor
Sensor compatible

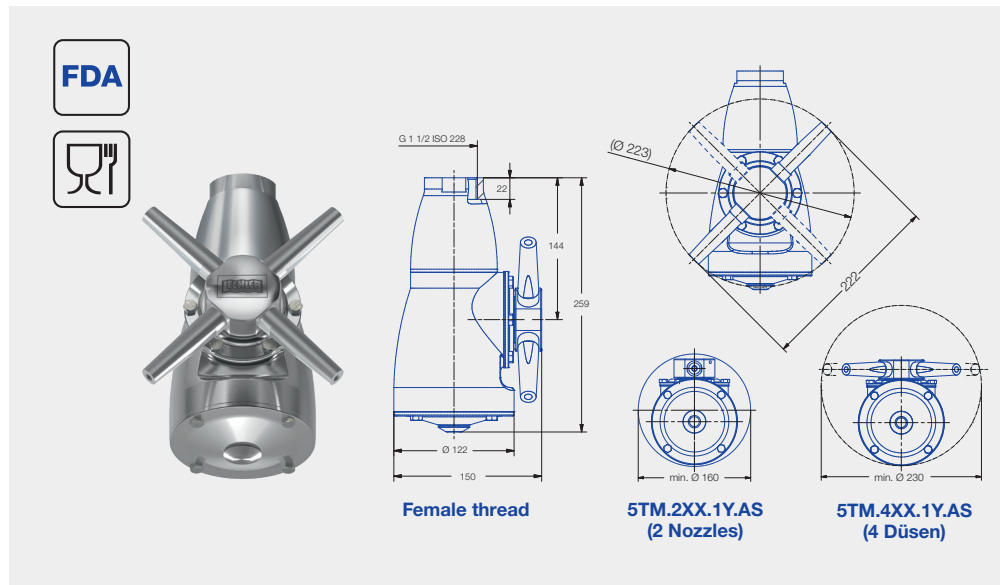

Spray-angle	Ordering no.	E Ø [mm]	Number, Ø Nozzles [mm]	V̇ [l/min]				Max. tank diameter [m]
				p [bar] (p _{max} = 7 bar)				
				2	3	5	at 40 psi [US gal./ min]	
360°	5TM.208.1Y.AS	8	2 x 8.0	125	153	198	39	24.0
	5TM.210.1Y.AS	10	2 x 10.0	160	196	253	50	24.0
	5TM.406.1Y.AS	6	4 x 6.0	140	171	221	43	18.0
	5TM.407.1Y.AS	7	4 x 7.0	170	208	269	53	20.0
	5TM.408.1Y.AS	8	4 x 8.0	200	245	316	62	22.0
	5TM.410.1Y.AS	10	4 x 10.0	260	318	411	81	23.0

E = Narrowest free cross-section

The maximum tank diameter shown above applies for the recommended operating pressure and is indicative only. The cleaning result is also affected by the type of soiling.

**ENGINEERING
YOUR SPRAY SOLUTION**



LECHLER WORLD-WIDE

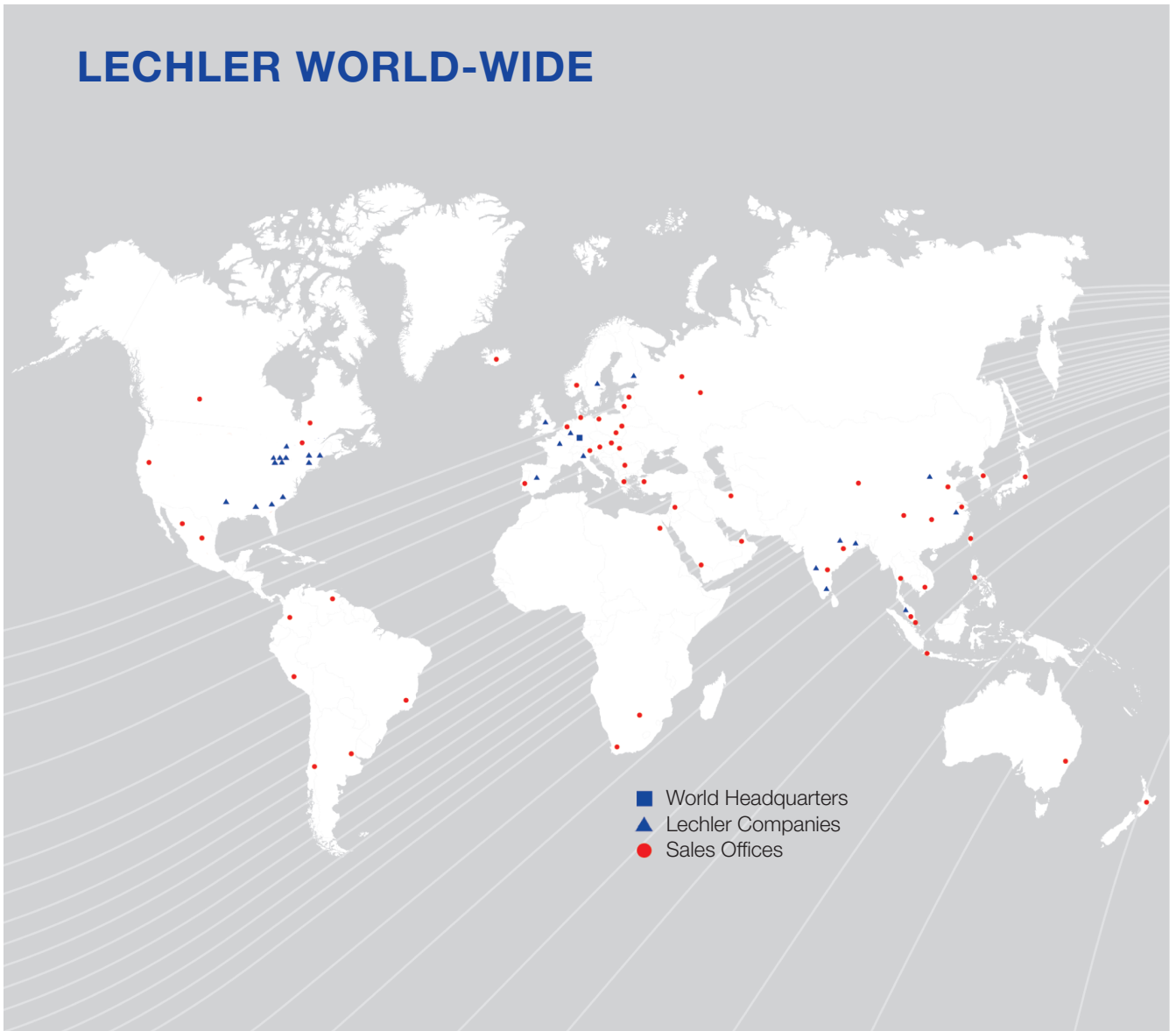

Lechler GmbH · Precision Nozzles · Nozzle Systems
P.O. Box 13 23 · 72544 Metzingen, Germany · Phone: +49 7123 962-0 · Fax: +49 7123 962-301 · info@lechler.de · www.lechler.com