

ENGINEERING
YOUR SPRAY SOLUTION



SPRAY NOZZLES AND ACCESSORIES FOR VITICULTURE, ORCHARD AND SPECIALTY CROPS

AGRICULTURE





LECHLER NOZZLES FOR
VITICULTURE, ORCHARD
AND SPECIALTY CROPS –
REACHING A HIGHER LEVEL



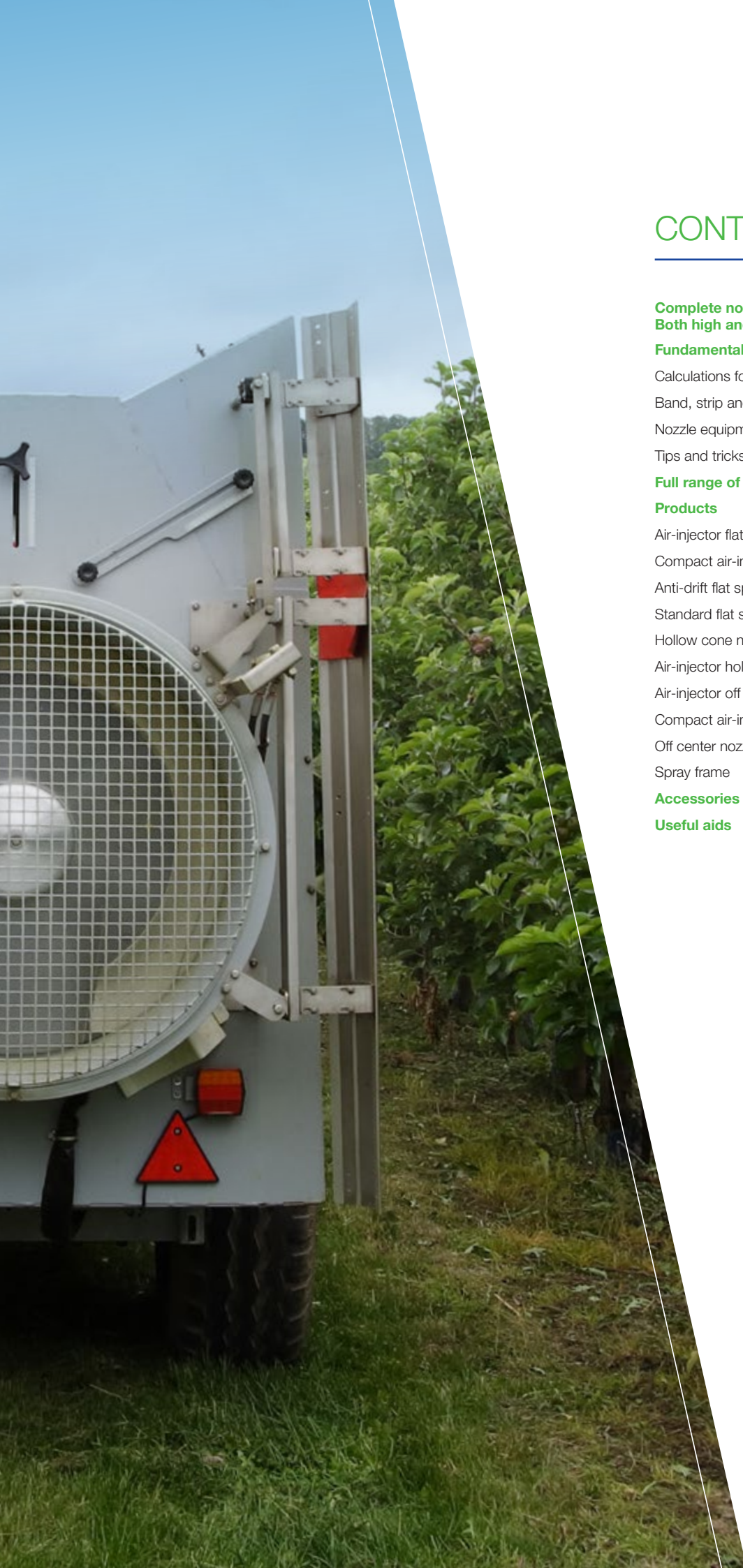

CONTENTS

Complete nozzle competence Both high and wide	4
Fundamentals of nozzle technology	
Calculations for viticulture, orchard and specialty crops	8
Band, strip and underplant treatment	10
Nozzle equipment for asparagus	12
Tips and tricks	14
Full range of nozzle competence	16
Products	
Air-injector flat spray nozzles ID	18
Compact air-injector flat spray nozzles IDK	19
Anti-drift flat spray nozzles AD	20
Standard flat spray nozzles ST	21
Hollow cone nozzles TR	22
Air-injector hollow cone nozzles ITR	23
Air-injector off center spray nozzles IS	24
Compact air-injector off center spray nozzles IDKS	25
Off center nozzles OC	26
Spray frame	27
Accessories	28
Useful aids	30



COMPLETE NOZZLE COMPETENCE – BOTH HIGH AND WIDE



Lechler is a world leader in nozzle technology. For over 140 years, we have pioneered numerous groundbreaking developments in the field of nozzle technology. Thanks to our decades of experience with drift-reducing technology, we have been able to make a significant contribution to more gentle and precise application of plant protection products.

We developed the ID 120-05 as early as the 1990s – the first JKI-approved nozzle with 90 % drift reduction for field crops. This also laid down a marker for future developments for viticulture, orchard and specialty crops.

The innovative ITR air-injector hollow cone nozzle was introduced in 1998. In 2017, it was approved in the 95 % drift reduction class for viticulture (insecticide treatment)

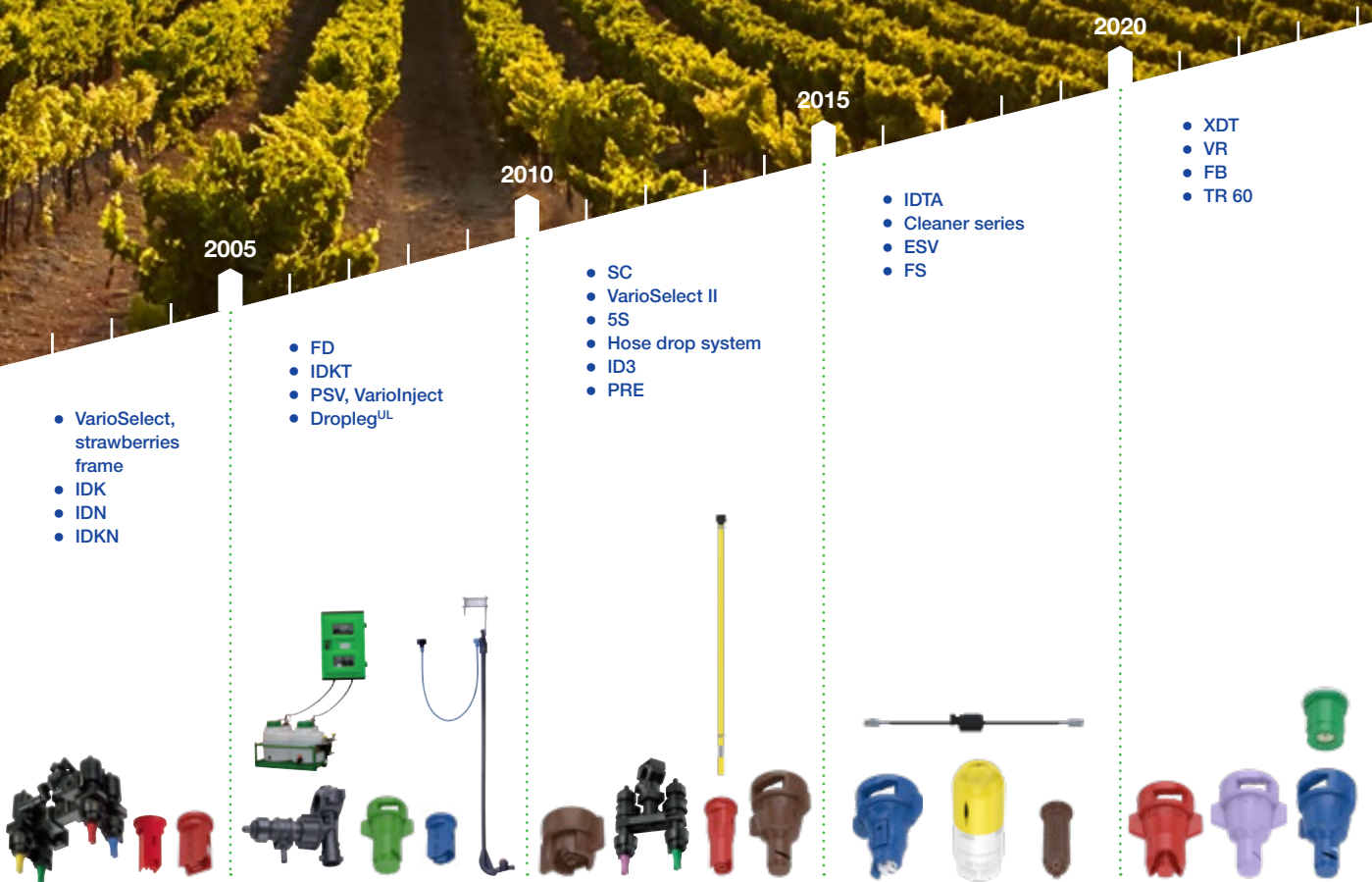























of *Drosophila suzukii*). The great breakthrough with drift reduction nozzles in sprayers was achieved more than 20 years ago with low-drift 90° flat spray nozzles. Many national and international approvals as loss-reducing technology with up to 99% drift reduction are available for the ID-90, IDK 90 and AD 90 series. We have consistently followed this path with ongoing new developments.

In Europe, Lechler has been the number one for nozzle technology for a long time now. However, we do not just see ourselves as a nozzle manufacturer, but above all as a partner in efforts to achieve both environmentally-friendly and efficient agriculture.



COMPLETE NOZZLE COMPETENCE BOTH WIDE AND HIGH

	Spraying with or without air support								Herbicide strip		
											
Series	ID	IDK	AD	IS*	IDKS**	ST***	TR	ITR	IS	IDKS	OC
Spray angle	90	90	90	80	80	20-120	80/60	80	80	80	90
Information on Page	18	19	20	24	25	21	22	23	24	25	26
Drift reduction	++	+	o	++	+	-	--	++	++	+	-
Spray geometry											
Recommended pressure range [bar]	2-8-15-20	2-8-15-20	2-8-15-20	2-8-15	2-8-15	1.5-10-30	2-8-20	3-10-30	2-4-8	1****-/1.5-3-6	1.5-2.5-5
Fungicides											
Contact	●●	●●	●●	●●	●●	●●	●●	●			
Systemic	●●	●●	●●	●●	●●	●●	●●	●●			
Insecticides											
Contact	●●	●●	●●	●●	●●	●●	●●	●			
Systemic	●●	●●	●●	●●	●●	●●	●●	●●			
Growth regulators	●●	●●	●●	●●	●●	●●	●●	●			
Herbicides									●●	●●	●●

Observe specifications of product manufacturers. * e.g. in over-row boom in combination with ID nozzles *** Special applications: strawberries, sweet cherries
 ** e.g. in over-row boom in combination with IDK nozzles **** IDKS-03/-04/-05/-06

-- = not drift-reducing - = slightly drift-reducing o = drift-reducing + = very drift-reducing ++ = highly drift-reducing

●● = very well-suited ● = well-suited ○ = less well-suited

Flat spray nozzles are becoming increasingly popular for applications in orchards and viticulture as well as specialty crops. In addition to the outstanding drift reduction of 99/95/90/75/50 % depending on the nozzle type, nozzle size, pressure range and blower type, they offer other decisive advantages compared with hollow cone nozzles:

- JKI approval as loss-reducing
- More uniform deposition
- Comparable to better biological efficacy
- No spot formation
- Better crop penetration
- Application is less dependent on weather
- User contamination is reduced to a minimum
- No wet blower due to targeted air flow impact
- No clogging due to large cross-sections in the injector and at the spray tip
- No spray mist during application – resulting in better acceptance in the population
- ISO color coding including TR/ITR hollow cone nozzles

Orchards

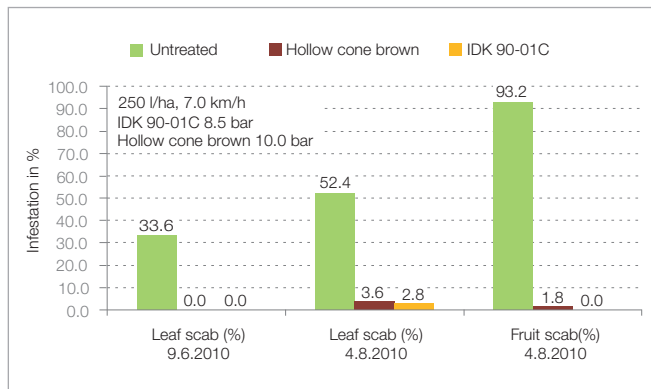

Diagram 1: Leaf and fruit scab on Elstar apples (source: KOB Bavendorf)

Conclusion:

IDK 90 compact air-injector nozzles demonstrate comparable to better biological efficacy against leaf and fruit scab compared with fine-droplet hollow cone nozzles.

Viticulture

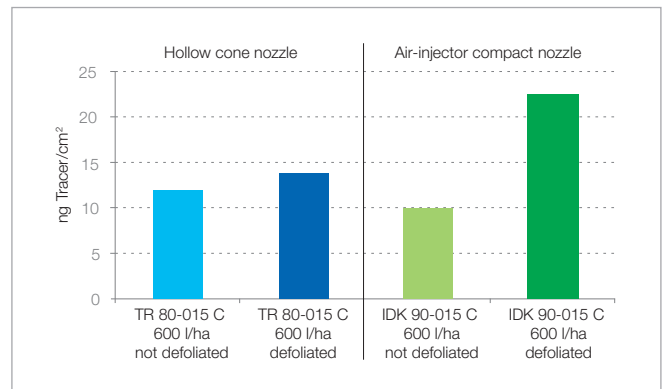

Diagram 2: Deposition at stalk framework (source: Syngenta)

Conclusion:

IDK 90 compact air-injector nozzles and hollow cone nozzles deposit the tracer well at the stalk framework. The IDK 90 offers clear advantages in the variant of partially defoliated grape zone.



FUNDAMENTALS OF NOZZLE TECHNOLOGY

CALCULATIONS FOR VITICULTURE, ORCHARD AND SPECIALTY CROPS

Calculation formula for viticulture, orchard and specialty crop applications

Sprayer equipment with nozzles of the same size

The flow rate of the individual nozzles is calculated by dividing the total nozzle output by the number of working nozzles. The nozzle size and pressure are determined from the flow rate on the basis of the tables (see Pages 32–35). The working width

corresponds to the distance between the driving lanes, i.e. it corresponds to the row spacing if every driving lane is used. If only every second driving lane is used, the working width corresponds to double the row spacing.

$$\dot{V} = \frac{M \times v_F \times B}{600}$$

\dot{V} = Total nozzle output [l/min]

M = Liter per hectare rate [l/ha]

v_F = Sprayer speed [km/h]

B = Working width/row spacing [m]

Sprayer equipment with nozzles of different sizes

If nozzles with different sizes are used simultaneously in one sprayer, the nozzle size is first determined that would be obtained in the case of equipment with nozzles offering identical performance.

The number of nozzles of the next-smaller nozzle size is taken into account corresponding to the total number of nozzles. In order to achieve the given liquid application rate (required value), the pressure must be increased in accordance with the following formula.

$$\text{Pressure setpoint} = \text{Pressure actual value} \times \left[\frac{\text{Total nozzle output setpoint}}{\text{Total nozzle output actual value}} \right]^2$$

Example

With a sprayer speed of 6.5 km/h, the required delivery is 600 l/ha. The working width is 2.0 m. The total nozzle output of the sprayer is then:

$$\frac{600 \times 6.5 \times 2.0}{600} = 13.00 \text{ l/min}$$

If 10 nozzles with the same nozzle size are used, the flow rate of each nozzle is $13.00 : 10 = 1.30$ l/min. Select nozzle/pressure according to spray table:

ID-90-02/yellow at 8.0 bar

Instead of the nozzle ID-90-02, the lower and two upper nozzles should be fitted with the next-smaller nozzle size 6 x ID-90-015/green on both sides of the sprayer. The total nozzle output (actual value) is as follows at 8.0 bar (actual value):

$$(6 \times 0.96 + 4 \times 1.30) \text{ l/min} = 10.96 \text{ l/min}$$

The pressure setpoint to be set for 600 l/ha (setpoint) is then:

$$8 \times \left[\frac{13.0}{11.0} \right]^2 = 11.2 \text{ bar}$$

Measuring the driving speed

60 s = 6.0 km/h
45 s = 8.0 km/h
36 s = 10.0 km/h

Example:

$$\frac{100 \text{ m} \times 3.6}{45 \text{ s}} = 8.0 \text{ km/h}$$

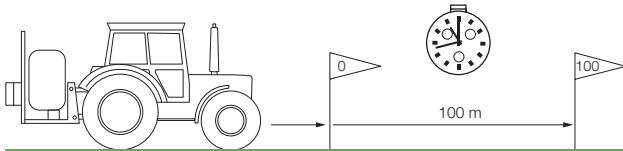

ISO color coding

The color coding of Lechler hollow cone and flat jet nozzles follows ISO standard 10625. It is possible to change to nozzles of another type but with the same size without recoding and conversion. Not all nozzle manufacturers follow the ISO color coding. If the make is changed, attention must be paid to possibly different color codes. See spray table, Pages 32 to 34, left column ATR in each case for ID/IDK/AD and TR/ITR.

Correct output measurement

- Fit hoses over nozzle body
- Seal with O-ring, if necessary
- Collect water at each nozzle (at the engine speed determined on the test section) for 1 minute (measuring beaker and stopwatch)

Compare the collected water with the previously collected quantity. If all individual values are too high or too low, re-adjust by changing pressure (pressure valve, pressure gauge).

Troubleshooting for nozzles

Nozzle clogged	clean
Nozzle damaged	replace
Nozzle worn	replace
Wrong nozzle (type/size)	replace
Filter clogged	clean
Diaphragm valve defective	replace

Assembly

Alignment of the flat jet spray jet of the ID, IDK, AD and ST nozzles parallel to the air flow of the blower. Use open-end wrench AF 10 (ID, ST) or AF 8 (IDK, AD) or nozzle adjusting wrench (Order no. **065.231.02.00.00**).

Assembly of nozzles with 2 mm collar:

- With cup strainer, gasket 3.0 mm (Order no. **065.240.73.01.00**)
- Without cup strainer, gasket 5.0 mm (Order no. **095.015.6C.07.10**)

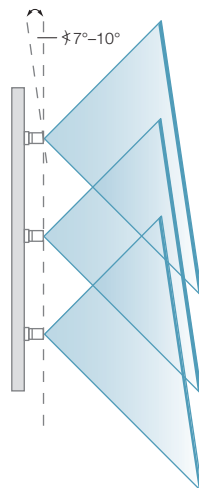

Good to know

The apps for Lechler agricultural nozzles make selection and use of the optimum nozzle even easier. Find out more here: www.lechler.com/de-en/service/apps



Nozzle
calculator
app





FUNDAMENTALS OF NOZZLE TECHNOLOGY

BAND, STRIP AND UNDERPLANT TREATMENT

Calculation for band, strip and underplant treatment

In viticulture, orchard and specialty crops, herbicides are normally delivered by nozzles installed in a band, strip, underplant or back sprayer. The flow rate is calculated on the basis of the following formula:

$$\dot{V} = \frac{1}{600} \times M \times v_f \times B$$

\dot{V} = Total nozzle output [l/min]

M = Liter per hectare rate [l/ha]

v_f = Sprayer speed [km/h]

B = Band/strip width[m]

Example for calculation of flow rate per nozzle

$M = 200$ l/ha, $v_f = 6.0$ km/h, $B = 0.5$ m







You can find the flow rates for the respective off center nozzles on Page 34.

$$\dot{V} = \frac{200 \times 6.0 \times 0.5}{600} = 1.00 \text{ l/min}$$

Recommendation

IS 80-025 at 4.7 bar or IDKS 80-04 at 2.1 bar.

Useful accessories for underplant spraying

	Designation	Order no.
	Swivel nozzle holder, max. 20 bar, swivel function in one plane	095.016.56.07.21
	Ball check valve 25 M ■	065.266.56.00.00
	Ball check valve 60 M ■	065.265.56.00.00
	Hose shank with male thread 1/4" NPT, hose dia. 10 mm	BHB025038
	Solenoid valve for hose connection	
	Hose dia. 11 mm	Z-Endvalve 11
	Hose dia. 13 mm	Z-Endvalve 00
	Micro 2-way valve 1/4"	BLV025V



Nozzle calculator app

The apps for Lechler agricultural nozzles for underplant treatment make selection and use of the optimum nozzle even easier. Find out more here: www.lechler.com/de-en/service/apps







FUNDAMENTALS OF NOZZLE TECHNOLOGY

NOZZLE EQUIPMENT FOR ASPARAGUS

The use of vertical asparagus spray booms is recommended for fungicide and insecticide treatments. These differ with respect to the number of nozzles and nozzle spacing.

Low-drift flat spray nozzles with a spray angle of 90° are the state-of-the-art. This is due to the coarser droplet spectrum with good penetration of the asparagus foliage and also a 90 % reduction in drift (current list available at www.lechler-agri.com).

Calculation example

800 l/ha, 6.0 km/h, row width 2.0 m

Total nozzle output of a vertical spray boom/row:

$$\frac{800 \times 6.0 \times 2.0}{600} = 16.00 \text{ l/min}$$

With 14 nozzles of the same size/series, the flow rate per nozzle is as follows:

$$\frac{16.00}{14} = 1.14 \text{ l/min}$$

Recommended nozzle equipment

Rotate nozzles forward by 15° in driving direction.

- ID-90 + IS 80 as boundary nozzle at top/bottom, pressure recommendation 8–15 bar
 - 4 x IS 80-02 at 11 bar
 - 10 x ID-90-015 C at 11 bar
- IDK 90 + IDKS 80 as boundary nozzle at top/bottom, pressure recommendation 2–6 bar
 - 4 x IDKS 80-03 at 4 bar
 - 10 x IDK 90-025 C at 4 bar

Nozzle equipment per row according to Karlsruhe system (one-side)

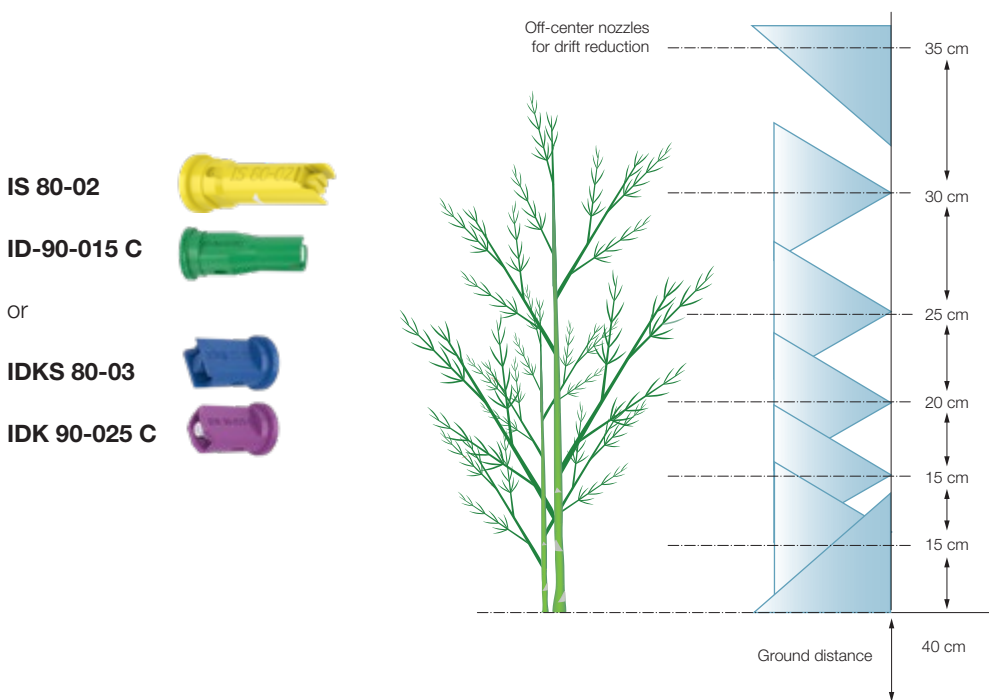



Asymmetrical, low-drift air-injector flat jet nozzles of the types IS and IDKS or conventional OC off center nozzles are recommended for herbicide applications in the dam or underplant area.



JKI approval as loss-reducing: 90%

Vertical spray booms for row crops asparagus, bush berries, viticulture.



Current list at:
www.lechler.com/de-en/service/loss-reducing



IS 80 (see Page 24)



IDKS 80 (see Page 25)



OC (see Page 26)

Settings

- Nozzle alignment according to dam form
- Adjustment of the working width by changing the spraying distance and rotating the spray axis
- Sprayer speed 4–6 km/h



Determine the nozzle size on the basis of the following selection criteria: liquid application rate, sprayer speed and recommended spraying pressure of the nozzle type.



FUNDAMENTALS OF NOZZLE TECHNOLOGY

TIPS AND TRICKS

Filter correctly

Malfunctions during operation caused by coarse particles can be prevented by use of the correct filter system. In order to protect the nozzle filter, we recommend selecting a mesh filter in the line strainer which is one category finer. The recommendations for the mesh size (M) of the nozzle filter/cup strainer are provided in the spray tables according to nozzle size.

Scheme for selecting the mesh size using the example of a sprayer for viticulture and orchards:

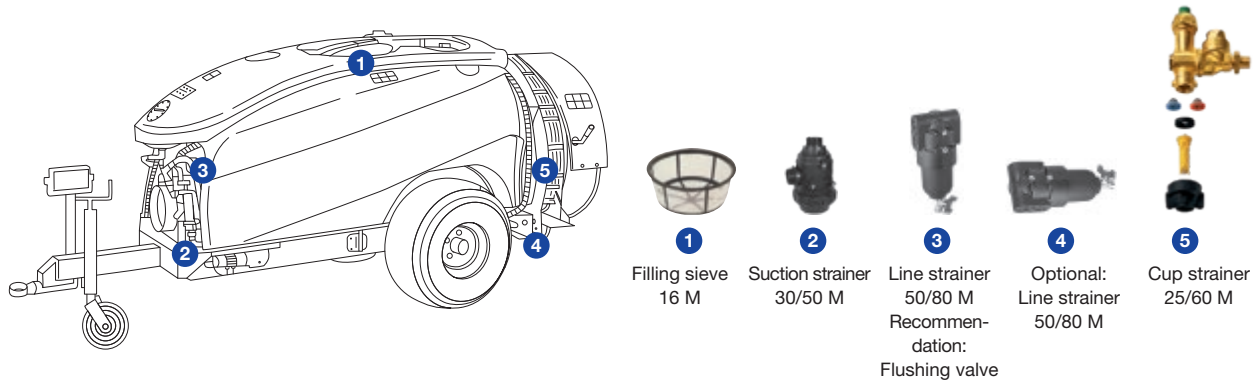

Avoid nozzle blockages

Properly functioning equipment is a prerequisite for successful crop protection. Clogged nozzles mean lost time and can lead to incorrect spray application. The following tips help to avoid mistakes.

Correct procedure:

- Observe the specified order when producing the spray mixture
- Always add only one product at a time
- Allow sufficient time to dissolve
- The mixer must guarantee good and homogeneous mixing of the plant protection product
- Match the filter in the equipment to the nozzle size
- Clean after use, e.g. with continuous internal cleaning
- Pay attention to water quality in relation to solubility of plant protection products

Avoid spray spots

Spray spots on fruit frequently occur as a result of the final treatments before harvesting, e.g. with fungicides. Not all plant protection products leave marks on the fruit surface. However, studies show that coarse-droplet application does not lead to spot formation if the following factors are taken into account:

Correct procedure:











- Reduce the l/ha rate to max. 150 l/ha per meter crown height in orchards
- Do not spray into dew-covered crops
- Do not add any additives

Color coding in accordance with ISO standard 19732 for filters since 2011

Old color code Lechler	Old color code ARAG	ISO 19732	Mesh
		New color code	
yellow		red	25
	white	red	32
	blue	blue	50
red		blue	60
	gray	yellow	80

Conversion table for original and new ISO color codes.

Assessment of nozzles

					
Series	ID-90	IDK 90	AD 90	TR 80/60	ITR 80
Spray geometry					
Installation length	42 mm	22 mm	11 mm	15 mm	34 mm
Biological efficacy	++	++	++	+	+
Wetting	+	+	++	++	+
Penetration	++	++	++	0	+
Drift resistance	++	++	++	--	++
Clogging tendency	+*	+*	+*	++	++
Risk of breakage	0	+	++	+	+

* Observe adapted filtering.

++ = very good/very low
 + = good/low
 0 = average
 - = high/low
 -- = very high/inadequate



NOZZLE COMPETENCE ACROSS THE BOARD



TECHNICAL REQUIREMENTS

Optimum application of plant protection products is guaranteed only if narrow flow rate tolerances and uniform distribution are ensured. These parameters are laid down in the JKI and ENTAM guidelines and in the corresponding EN/ISO standards on European and international level.

In the case of JKI-approved Lechler nozzles, the volume flow of new nozzles may deviate from the table value by a maximum of $\pm 5\%$.



JKI-approved Lechler nozzles for viticulture, orchard and specialty crops must comply with narrow tolerances with respect to the flow rate. New nozzles must deviate by no more than $\pm 5\%$ from the joint average

value and nozzles that are in use by no more than $\pm 15\%$. With symmetrical equipment, the liquid flow rate on the left and right sides must be $50\% \pm 5\%$ of the total flow rate. This is checked in accordance with ISO 5682-2 and JKI Guideline 1-2.1.

BIOLOGICAL REQUIREMENTS

In order to achieve the optimum effect, application of plant protection products must be extremely precise. Lechler precision nozzles achieve exact dosage and uniform distribution. Independently of this, the recommendations of the plant protection product manufacturers with respect to l/ha quantities must always be observed. Determination of the application area before use is of decisive importance for optimum deposition of the plant protection product.

Delivery takes place flat via flat fan and double flat fan nozzles. Flat spray nozzles generally achieve good crop penetration (e.g. mildew control in viticulture).



ENVIRONMENTALLY-RELEVANT REQUIREMENTS

The wind and thermal currents can cause some of the droplets containing the active ingredients to miss the target area. This drift can pollute or damage adjacent crops, contaminate nearby waters and pose a risk to both humans and animals. In addition, drift frequently leads to incorrect dosages for the crop being treated.

The causes of drift depend on equipment-specific and meteorological factors such as:

- Droplet size
- Sprayer velocity
- Spray height
- Wind speed
- Air temperature
- Air humidity

LOSS-REDUCING EQUIPMENT

Application regulations for plant protection products, e.g. distance restrictions to water and field boundary structures, have been defined in order to protect non-target organisms. Depending on the toxicity of the plant protection product, the distances from water and field boundaries can be reduced with loss-reducing equipment, e.g. with air-injector nozzles.

Lechler nozzles are officially approved in many European countries as drift-reducing devices in the drift reduction classes 99/95/90/75/66/50 and 25 %. The criteria on which the distance regulations are based in the individual countries comprise, among other things, the nozzle technology, water type, bank vegetation, width of the field boundary, mixture concentration, process technology (e.g. pressure) as well as external influences such as wind direction, wind speed and temperature.

Drift-reducing Lechler nozzles allow areas to be used more efficiently while at the same time protecting field boundaries and water.

Air-injector flat spray nozzles ID-90

ID3

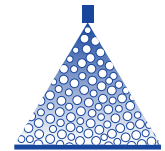

Crop production

- Air-aspirating flat spray nozzle
- Extremely low drift over the entire pressure range

Advantages

- In new, optimized ID3 design
- Extended pressure range from 2 to 20 bar
- Exceptionally low-drift also in the high pressure range up to 20 bar
- Large, clogging-resistant flow cross-sections
- Significantly improved crop penetration
- Suitable for PWM



Series ID-90

Dimensions in mm.

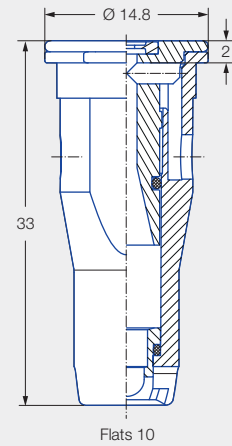

Injector can be removed without tools

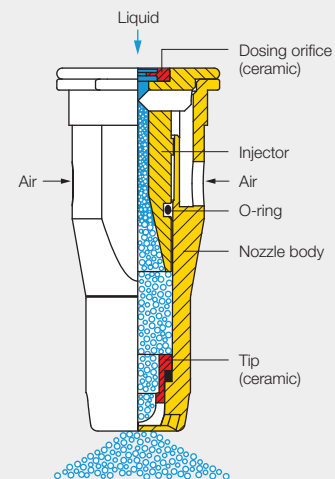

Application:



Plant protection products and growth regulators



Plant protection in viticulture, orchard and specialty crops



Sensor control



Vertical boom



Spray frame

Technical data:



Nozzle sizes
01-06



Spray angle
90°



Material
Ceramic



Pressure ranges
2-8-15-20 bar



Recommended filters
• 60 M 01-04
• 25 M 05-06



Droplet sizes
Ultra coarse - medium



Width across flats
10 mm

Please observe our assembly tips on Page 9 for assembly and alignment of ID-90 nozzles.

Compact air-injector flat spray nozzles IDK 90

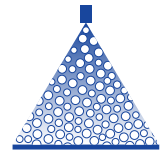

Crop production

- Air-aspirating flat spray nozzle
- Extremely low drift over the entire pressure range

Advantages

- 99/95/90/75/50 % drift reduction for: IDK 90-0067 C to -02 C
- Only 7 mm longer than TR hollow cone nozzle
- Large, clogging-resistant cross-sections
- Breakage-resistant nozzle housing with beveled edges and reinforced walls
- Suitable for PWM



IDK 90-01 C

75 % drift reduction in accordance with MABO dosage model

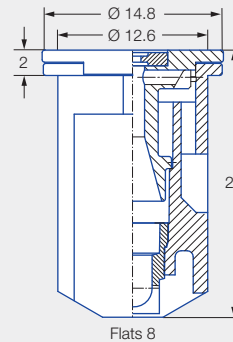

Dimensions in mm.

Series IDK 90



JKI approval as loss-reducing: 99/95/90/75/50%

G 1834, G 1835, G 1886, G 1941, G 2052, G 2053



Current list at: www.lechler.com/de-en/service/loss-reducing



Injector can be removed without tools

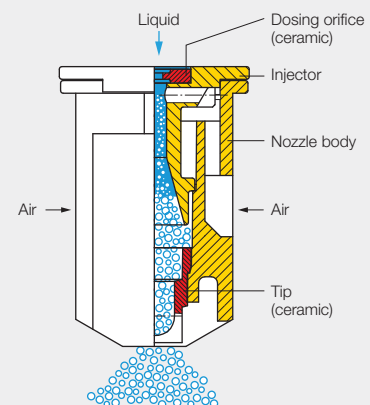

Application:



Plant protection products and growth regulators



Plant protection in viticulture, orchard and specialty crops



Sensor control



Vertical boom



Spray frame

Technical data:



Nozzle sizes
0067-06



Spray angle
90°



Material
Ceramic



Pressure ranges
2-8-15-20 bar



Recommended filters

- 60 M 0067-04
- 25 M 05-06



Droplet sizes
Extremely coarse – fine



Width across flats
8 mm

Please observe our assembly tips on Page 9 for assembly and alignment of IDK 90 nozzles.

Anti-drift flat spray nozzles AD 90

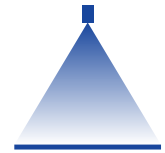

Crop production

Dimensions in mm.

- Low-drift flat spray nozzle

Advantages

- 99/95/90/75/50 % drift reduction for:
AD 90-01 C to -04 C
- Fine droplets at higher pressure
- Pre-atomizer can be removed without tools
- NEW** • Pre-atomizer has flush contact with twist lock
- Ideal for cramped installation conditions (4 mm shorter than TR hollow cone nozzle) thanks to compact design
- Ideal for sensor control thanks to very fast jet build-up and reduction
- Suitable for PWM



Series AD 90

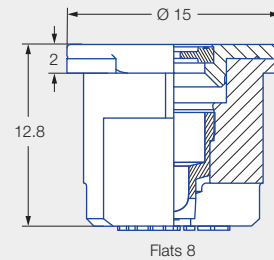

Removable pre-atomizer

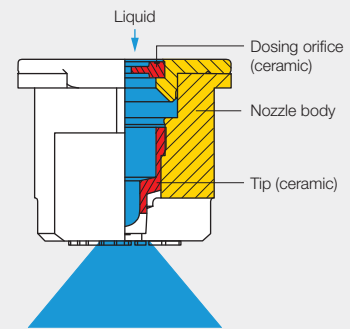

JKI approval as loss-reducing: 99/95/90/75/50%

G 1666, G 1667, G 1668, G 2041, G 2042



Current list at:
www.lechler.com/de-en/service/loss-reducing

Application:



Plant protection products and growth regulators



Plant protection in viticulture, orchard and specialty crops



Sensor control



Vertical boom

Technical data:



Nozzle sizes
0067-04



Spray angle
90°



Material
Ceramic



Pressure ranges
2-8-15-20 bar



Recommended filters
60 M 0067-04



Droplet sizes
Coarse - fine



Width across flats
8 mm

Please observe our assembly tips on Page 9 for assembly and alignment of AD 90 nozzles.

Standard flat spray nozzles ST 652



Crop production

Dimensions in mm.

- Low-pressure flat spray nozzle

Advantages

- Large range of different nozzle sizes, spray angles and materials
- Large range for standard tree applications due to narrow spray angle and high droplet speed
- Banding in strawberry crops, e.g. against rhizome rot, with ST 60°
- Wide pressure range up to 30.0 bar



Series ST 652

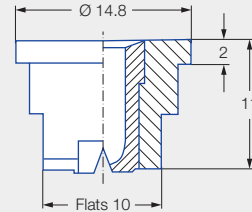

Application:



Plant protection products and growth regulators



Plant protection in viticulture, orchard and specialty crops

Technical data:



Nozzle sizes
01–20



Spray angle
120°, 90°, 60°,
45°, 30°, 20°



Material
Brass, stainless steel,
PVDF



Pressure ranges
1.5–10–30 bar



Recommended filters

- 60 M 02–04
- 25 M 05–12



Droplet sizes
Medium – very fine



Width across flats
10 mm

Standard tree application, e.g. sweet cherry at 4.0 km/h, 25.0 bar, 1,630 l/ha, planting 8 x 8 m

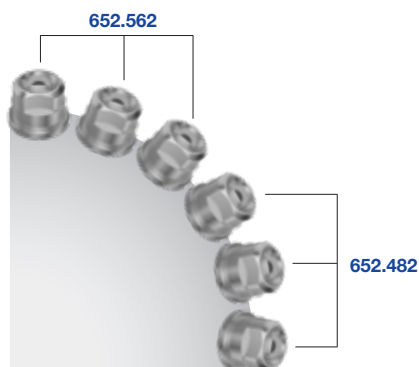

Example equipment (one-side) of an axial blower with flat jet nozzles 30°.

Nozzle ST	[l/min]	[l/min]					
		5.0	10.0	15.0	20.0	25.0	30.0
02	60 M	1.00	1.40	1.73	2.0	2.24	2.45
03	60 M	1.58	2.24	2.74	3.16	3.53	3.87
04	60 M	1.98	2.80	3.43	3.96	4.43	4.85
05	25 M	2.53	3.58	4.38	5.06	5.66	6.20
08	25 M	3.95	5.59	6.84	7.90	8.83	9.68
12	25 M	6.33	8.94	10.96	12.66	14.15	15.51

Please observe our assembly tips on Page 9 for assembly and alignment of ST nozzles.

Hollow cone nozzles

TR 80/TR 60

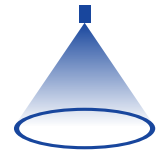

Crop production

Ground care

Dimensions in mm.

- Fine-droplet hollow cone nozzle with 60° and 80° spray angle

TR 80 advantages

- Optimized, narrow droplet spectrum
- Fine droplets ensure high coverage
- Nozzle insert secured to prevent it falling out by means of snap closure
- Resistant to clogging due to round hole bore
- Suitable for PWM



Series TR 80

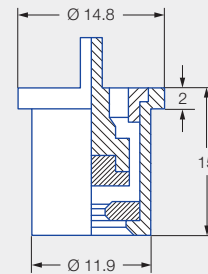

NEW TR 60 advantages

- Improved image of air flow due to spray angle of 60°
- Simple handling also with protective gloves
- Quick insert removal without tools for cleaning
- Increased stability thanks to reinforced housing
- Even more uniform spray pattern thanks to new swirl insert design
- Increased wear resistance
- Available with 2 mm and 5 mm nozzle collar
- Suitable for PWM

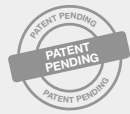

Series TR 60

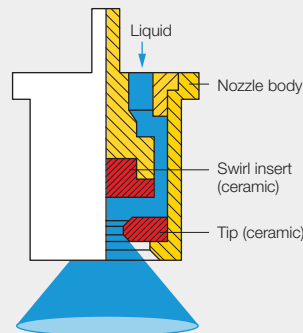
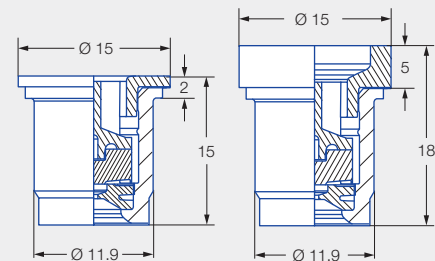

TR 80

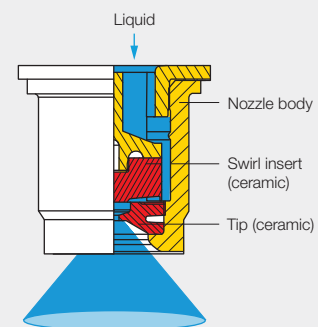

TR 60

Application:



Plant protection products and growth regulators



Plant protection in viticulture, orchard and specialty crops



Backpack sprayer



Greenhouse

Technical data:



Nozzle sizes
005-05



Spray angle
60°, 80°



Material
Ceramic



Pressure ranges

- TR 80:
3-8-20 bar
- TR 60:
2-8-20 bar



Recommended filters

- 60 M 005-04
- 25 M 05



Droplet sizes
Fine - very fine



Union nut
Ø 11.9 mm

➤➤ Air-injector hollow cone nozzles ITR 80

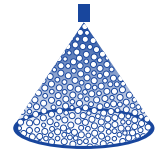

Crop production

Ground care

- Air-aspirating hollow cone nozzle
- Extremely low drift over the entire pressure range

Advantages

- 95/90/75/50 % drift reduction – ITR 80-01 C
- Exceptionally low-drift design
- Resistant to clogging due to round hole bore
- ISO color-coded
- Suitable for PWM



Series ITR 80

Dimensions in mm.

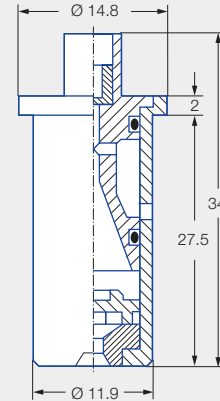

JKI approval as loss-reducing:
95/90/75/50 %

G 2023



Current list at:
www.lechler.com/de-en/service/loss-reducing



Injector can be removed without tools

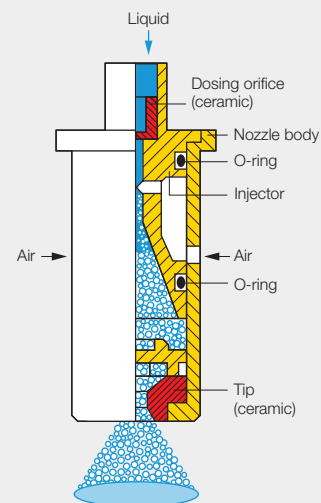

Application:

Plant protection products and growth regulators

Plant protection in viticulture, orchard and specialty crops

Technical data:

Nozzle sizes
01-02

Spray angle
80°

Material
Ceramic

Pressure ranges
3-10-30 bar

Recommended filters
60 M 01-02

Droplet sizes
Extremely coarse – medium

Union nut
Ø 11.9 mm

➤ Air-injector off center spray nozzles IS 80

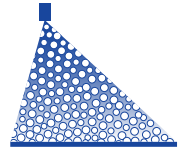

Crop production

Ground care

- Air-aspirating off center nozzle for border application and banding
- Extremely low-drift

Advantages

- 90 % drift reduction for strip spraying with IS 80-03
- Same JKI drift reduction class in combination with ID/IDTA nozzles in the field spray boom
- Volume flow adapted for optimum cross distribution in combination with ID/IDTA nozzles of the same size
- Asymmetrical spray pattern (20°/60° to axis)
- Precise edge application along water courses and field boundaries
- Optimum protection of neighboring crops (field border application or row/special cultures (herbicide underleaf spraying/banding))
- Suitable for PWM



Series IS 80



Injector can be removed without tools

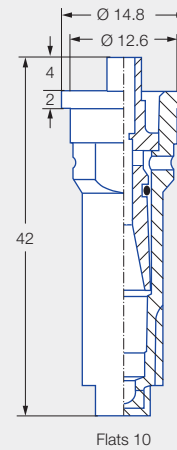

Dimensions in mm.

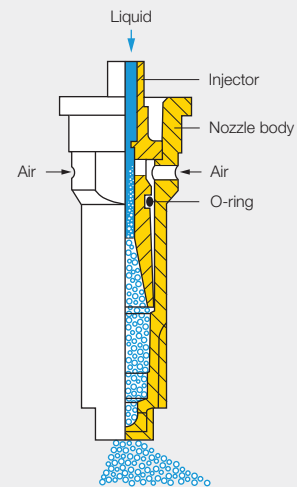

JKI approval as loss-reducing: 90/75/50%

G 1682, G 1753, G 1754, G 1755, G 1999, G 2000, G 2087

JKI approval with ID/IDTA nozzles of the same size.



Current list at: www.lechler.com/de-en/service/loss-reducing

Application:

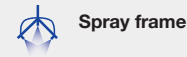
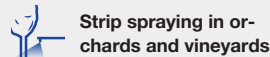

Technical data:

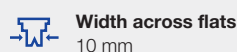
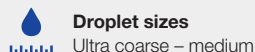
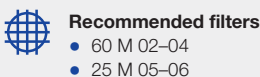
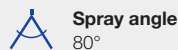
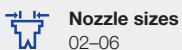

- Field sprayer/underplant sprayer: 2-4-8 bar
- Vertical boom: 2-8-15 bar

Compact air-injector off center spray nozzles IDKS 80

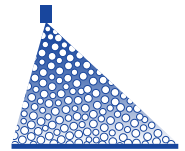

Crop production

Ground care

- Compact, air-aspirating off center nozzle for border application and banding
- Very low drift

Advantages

- 90 % drift reduction for strip spraying with IDKS 80-025 to -06
- Same JKI drift reduction class in combination with IDK/IDKN/IDKT nozzles in the field spray boom
- Volume flow adapted for optimum cross distribution in combination with IDK/IDKN/IDKT nozzles of the same size
- Precise edge application along water courses and field boundaries
- Optimum protection of neighboring crops (field edge application or row/special cultures (herbicide underleaf spraying/banding))
- Suitable for PWM



Series IDKS 80



Injector can be removed without tools

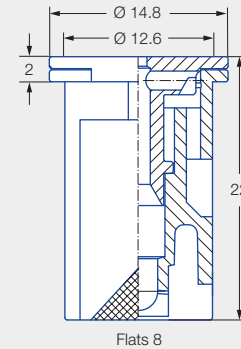

Dimensions in mm.

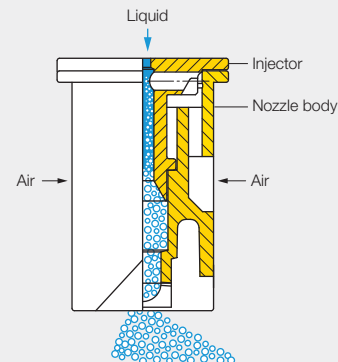

JKI approval as loss-reducing: 90/75/50 %

G 1786, G 1787, G 1788, G 1789, G 1998, G 2139, G 2140, G 2141, G 2142, G 2143

JKI approval with IDK/ IDKN/IDKT nozzles of the same size.



Current list at: www.lechler.com/de-en/service/loss-reducing

Application:



Border nozzle



Plant protection in viticulture, orchard and specialty crops



Vertical boom



Spray frame



Backpack sprayer



Greenhouse

Technical data:



Nozzle sizes
015-06



Spray angle
80°



Material
POM



Pressure ranges

- Field sprayer/ underplant sprayer: 1-1.5-3-6 bar
- Vertical boom: 1-8-15 bar



Recommended filters

- 60 M 015-04
- 25 M 05-06



Droplet sizes
Ultra coarse – medium



Width across flats
8 mm

Off center nozzles OC

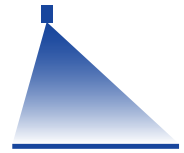

Crop production

Ground care

Dimensions in mm.

- Off center nozzle for border application and banding

Advantages

- Laterally offset orifice
- Asymmetrical flat spray nozzle

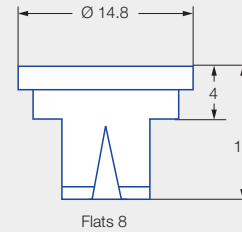

Series OC

Application:



Border nozzle



Strip spraying
in orchards and
vineyards



Vertical boom



Spray frame



Backpack sprayer



Greenhouse



Riding arena floor

Technical data:



Nozzle sizes
2-30



Spray angle
90°



Materials
Brass, stainless steel



Pressure ranges
1.5-2.5-5 bar



Recommended filters

- 60 M 2-4
- 25 M 5-30



Droplet sizes
Medium - fine



Width across flats
8 mm

Spray dimensions

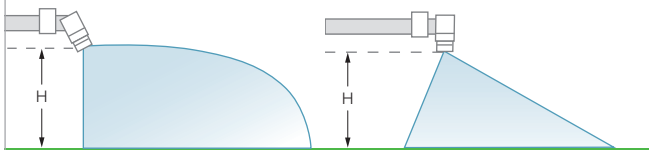

OC nozzle tips fitted in individual or double swivel joints permit adjustment to any angle. Wide and narrow spray jet widths can be achieved in this way.

Precise border spraying

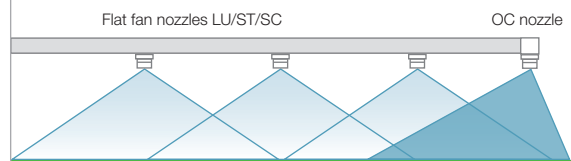



Dimensions in mm.

- 3-nozzle fork for uniform spraying and penetration of row crops

Advantages

- Variable nozzle equipment, e.g. with twin (IDKT at top) and flat spray nozzles (IDK at sides)
- Uniform wetting and crop penetration at the sides and from above
- Flexible adaptation to individual crops by adjustable spray arms
- Robust, wear-resistant spray arm design in stainless steel
- Problem-free assembly on every spray boom

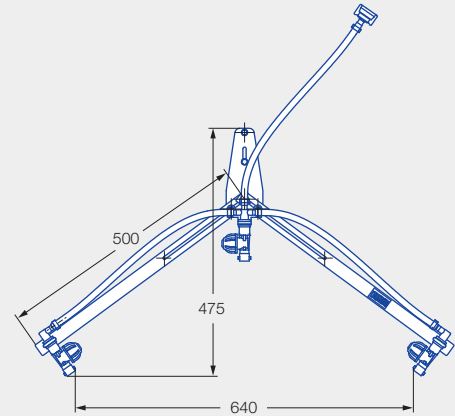

Application:



Plant protection products



Strawberries

Technical data:



Opening angle
Spray arms:
55°–107°



Materials
Stainless steel, PA



Pressure range
Max. 8 bar

Note

Nozzle equipment with:

ID (90°/120°), IDK (90°/120°), IDKN, IDKT, IS, IDKS, LU (90°/120°), ST (60°), DF, E, TR, OC.

Calculation example

1.000 l/ha, 4.0 km/h, row spacing 0.9 m

The **total nozzle output** of a spray frame for area treatment:

$$\frac{1.000 \times 4.0 \times 0.9}{600} = 6.00 \text{ l/min}$$

With three nozzles of the same size/series, the flow rate per nozzle is as follows:

$$6.00 \text{ l/min} : 3 = 2.00 \text{ l/min}$$

Recommendation

IDKT 05 (top) at 3.0 bar

IDKS 80-06 (lateral) at 3.0 bar

Order no. 092.165.00.00.00

Scope of delivery: Spray frame without nozzles, nozzle strainer, gaskets and bayonet caps



Item	Designation	Thread	Mesh size	Order no.
①	Bayonet diaphragm nozzle holder incl. threaded cap and bayonet cap Opening pressure: 0.7 bar Closing pressure: 0.7 bar Max. working pressure: 25 bar	G 1/4 male		ZTRA.EGE.RK.OM.B
②	Combination bayonet cap for AF 8 and 10 incl. seal (spare)			BRI.806.18.38.00
③	Seal for bayonet cap (spare)			BRI.300.60.13.10
④	Threaded cap (spare)			BRI.756.05.46.00
	Seal for threaded cap (spare)			BRI.356.01.38.00
⑤	Cup strainer (optional)		25 M	200.029.26.00.03
			60 M	200.029.1C.01.03
⑥	Nozzle			

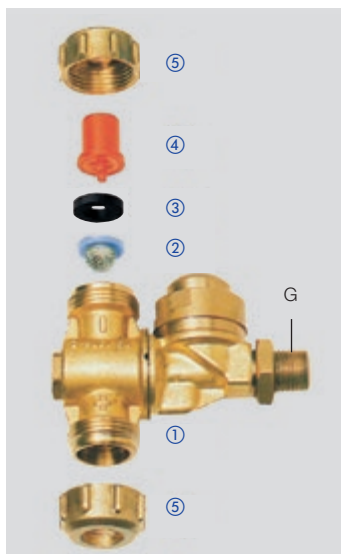

Item	Designation	Thread	Mesh size	Seal Thickness [mm]	Order no.
①	Diaphragm nozzle holder incl. 2 threaded caps (item 5) Opening pressure: 1.1 bar Closing pressure: 0.9 bar Max. working pressure: 40 bar	G 1/4 male (as Fig.)			095.016.30.09.61
		G 1/4 female (not shown)			095.016.30.09.62
②	Cup strainer (optional)	25 M	25 M		200.029.26.00.03
		60 M	60 M		200.029.1C.01.03
③	Flat seal, rubber			3.0	065.240.73.01.00
				5.0	095.015.6C.07.10
④	Nozzle				BRI.756.05.46.00
⑤	Threaded cap (spare)				BRI.356.01.38.00



Item	Designation	Thread	Order no.
①	Reduction socket	M 18 x 1.5 female / G 1/4 female	095.016.30.12.80
②	Reduction socket	G 3/8 female / G 1/4 female	095.019.30.00.23
③	Reduction coupling	G 3/8 male / G 1/4 female	065.221.30.00.00

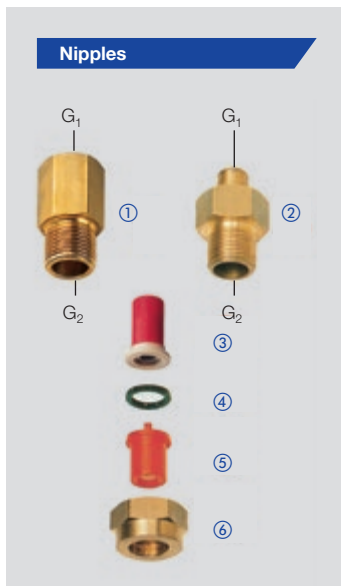

Item	Designation	Thread		Mesh size	Seal Thickness [mm]	Order no.
		G ₁	G ₂			
①	Connection nipple with female thread	M 11 x 1 female	G 3/8 male			065.222.30.00.00
		G 1/4 female	G 3/8 male			065.228.30.00.00
②	Connection nipple with male thread	M 11 x 1 male	G 3/8 male			065.213.30.00.00
		G 1/4 male	G 3/8 male			065.215.30.00.00
③	Ball check-valve, POM, opening pressure: 2.5 bar			25 M		065.266.56.02.00
				60 M		065.265.56.02.00
④	Flat seal, rubber				1.6	065.240.73.00.00
⑤	Nozzle					
⑥	Threaded cap G 3/8 female					065.200.30.00.00



Designation	Order no.
Solenoid valve for hose connection max. 10 bar, max. 30 l/min Current consumption: 0.5 A	
Hose dia. 11 mm	Z-Endvalve 11
Hose dia. 13 mm	Z-Endvalve 00
Valve tappet (spare)	Z-E06011.00



Item	Designation	Thread		Mesh size	L [mm]	Order no.
		G ₁	G ₂			
①	Swivel nozzle holder, max. 20 bar (incl. threaded cap and seal)	G 1/4 male	G 3/8 male		35	095.016.56.07.22
		1/4" NPT female	G 3/8 male		35	095.016.56.07.21
②	Seal				1.6	065.240.73.00.00
③	Threaded cap		G 3/8		22	065.200.56.00.00
	Ball check valve, POM, opening pressure 0.5 bar			25 M		065.266.56.02.00
				60 M		065.265.56.02.00



Max. flow rate [l/min]	Order no.	Connection	Dimensions [mm]		Order no. Strainer insert (incl.)
			D	L	
150	A345.033.00.00.00	G 1/2 female / G 3/4 female	104	259	50 M
150	A345.033.50.00.00	G 1/2 female / G 3/4 female	104	259	80 M

Designation	Order no.
Plug G 1/2	A004.010.02.00.00
Gasket for G 1/2 plug	A403.000.06.00.00
Plug G 3/4	A465.230.02.00.00
Gasket for G 3/4 plug	A465.005.14.00.00

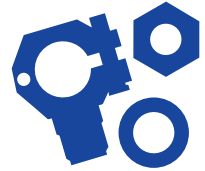

Good to know

You can find detailed information in our “Assembly Instructions Electric Border Valve Kit” and at www.lechler.com/de-en/support.



Anemometer Pocketwind IV

- Backlit display
- Waterproof and shockproof housing
- Lanyard
- Integrated hard cover for protection against damage and dirt
- Tripod thread

Advantages

- Self-calibrating humidity sensor
- Hard cover protects measuring sensors against damage
- Measures all relevant application parameters

Measuring functions

- Air humidity
 - Relative humidity
 - Dew point
 - ΔT
 - Wet bulb thermometer
- Wind speed
 - Maximum
 - Average
 - Switchable units m/s, km/h, fpm, mph, kn and bft
- Temperature/wind chill units
 - $^{\circ}C$ and $^{\circ}F$, switchable
- Wind direction
 - Digital compass
 - Integrated wind vane



Order no.

ZWIN.DME.SS.ER.01

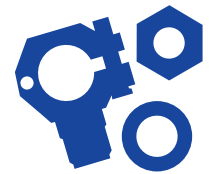

Water-sensitive paper

Size: 76 x 26 mm
Order no. **ZWSP.76X.26.00.00**

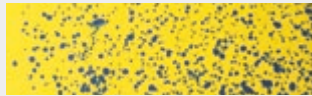

Nozzle cleaning brush

Order no. **095.009.50.10.89**



Nozzle aligner

Order no. **065.231.02.00.00**

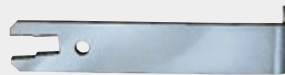

Nozzle assembly wrench

Order no. **092.164.40.00.99**



Spray table for viticulture, orchard and specialty crops

DIN A5

ID/IK/AD/TR/ITR	Q	V	U	W	ISO
04	05	06	07	08	09
10	11	12	13	14	15
16	17	18	19	20	21
22	23	24	25	26	27
28	29	30	31	32	33
34	35	36	37	38	39
40	41	42	43	44	45
46	47	48	49	50	51
52	53	54	55	56	57
58	59	60	61	62	63
64	65	66	67	68	69
70	71	72	73	74	75
76	77	78	79	80	81
82	83	84	85	86	87
88	89	90	91	92	93
94	95	96	97	98	99
100	101	102	103	104	105

Nozzle calculator app

The Lechler agricultural nozzle app makes it easy to select the right nozzle for your application.

On the basis of the selected sprayer speed and application rate, the app shows you the suitable nozzles and corresponding droplet size categories. This allows you to quickly find the suitable Lechler nozzle and thus optimize your application.

All values are based on measurements with water.



Apple



Android

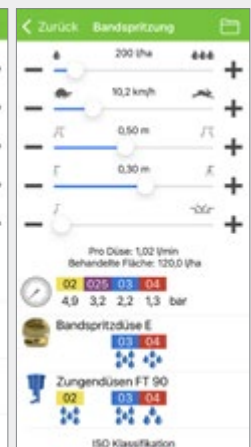
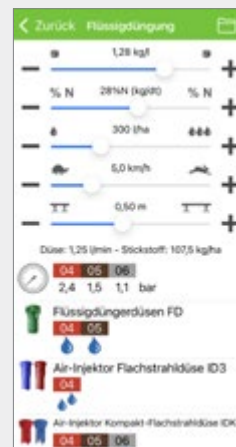



Spray table

Important information at a glance

Pressure

Nozzle	[bar]
ID 01-06:	2-8-15-20
IDK 0067-06:	2-8-15-20
AD 0067-04:	2-8-15-20
ST 01-20:	1.5-10-30
TR 80 005-05:	3-8-20
TR 60 005-05:	2-8-20
ITR 01-02:	3-10-30
IS 02-06:	
Field sprayer/ underplant sprayer:	2-4-8
Vertical boom:	2-8-15
IDKS 015-06:	
Field sprayer/underplant sprayer:	1-1.5-3-6
Vertical boom:	1-8-15
OC 2-30:	1.5-2.5-5

Nozzle filter (M = mesh/inch)

General:

60 M

Exceptions:

25 M

ID 05-06, IDK 05-06





ISO 25358 classification according to droplet sizes:

VF	Very fine
F	Fine
M	Medium
C	Coarse
VC	Very coarse
EC	Extremely coarse
UC	Ultra coarse

Subject to modifications.

- Operating pressure at the nozzle (measured with diaphragm valve)
- The stated liter-per-hectare rates apply to water
- Verify the table values by gauging the flow rates prior to every spraying season
- Pay attention to uniform nozzle adjustment

ATR	ISO 10625	Nozzle	Nozzle spray pattern			Nozzle spray pattern		Flow rate [l/min]	
			ID	IDK	AD	TR	ITR		
-005	60 M							2.0	0.16
						VF		3.0	0.20
						VF		4.0	0.23
						VF		5.0	0.25
						VF		6.0	0.28
						VF		7.0	0.30
						VF		8.0	0.32
						VF		9.0	0.34
						VF		10.0	0.36
						VF		11.0	0.38
						VF		12.0	0.39
						VF		13.0	0.41
						VF		14.0	0.42
						VF		15.0	0.44
						VF		16.0	0.45
						VF		17.0	0.47
						VF		19.0	0.49
			VF		20.0	0.51			
-0067	60 M			EC	F			2.0	0.22
				EC	F	VF		3.0	0.27
				VC	F	VF		4.0	0.31
				VC	F	VF		5.0	0.35
				VC	VF	VF		6.0	0.38
				C	VF	VF		7.0	0.41
				C	VF	VF		8.0	0.44
				M	VF	VF		9.0	0.47
				M	VF	VF		10.0	0.49
				M	VF	VF		11.0	0.52
				M	VF	VF		12.0	0.54
				M	VF	VF		13.0	0.56
				M	VF	VF		14.0	0.58
				M	VF	VF		15.0	0.60
				M	VF	VF		16.0	0.62
				M	VF	VF		17.0	0.64
				F	VF	VF		19.0	0.68
	F	VF	VF		20.0	0.70			
-01	60 M			VC	C			2.0	0.32
				VC	C	VF	EC	3.0	0.39
				VC	M	VF	EC	4.0	0.45
				VC	C	VF	VC	5.0	0.51
				VC	C	VF	VC	6.0	0.55
				VC	C	VF	VC	7.0	0.60
				VC	M	VF	VC	8.0	0.64
				C	M	VF	VC	9.0	0.68
				C	M	VF	VC	10.0	0.72
				C	M	VF	VC	11.0	0.75
				C	M	VF	C	12.0	0.78
				C	M	VF	C	13.0	0.82
				M	M	VF	C	14.0	0.85
				M	M	VF	C	15.0	0.88
				M	F	VF	C	16.0	0.91
				M	F	VF	C	17.0	0.93
				M	F	VF	M	19.0	0.99
	M	F	VF	M	20.0	1.01			
-015	60 M			VC	C		VC	2.0	0.48
				VC	M	VF	VC	3.0	0.59
				VC	M	VF	VC	4.0	0.68
				VC	C	VF	VC	5.0	0.76
				VC	C	VF	VC	6.0	0.83
				VC	M	VF	VC	7.0	0.90
				VC	M	VF	VC	8.0	0.96
				VC	M	VF	VC	9.0	1.02
				VC	M	VF	C	10.0	1.07
				C	M	VF	C	11.0	1.13
				C	M	VF	C	12.0	1.18
				C	M	VF	C	13.0	1.22
				C	M	VF	C	14.0	1.27
				C	M	VF	M	15.0	1.31
				C	M	VF	M	16.0	1.36
				M	M	VF	M	17.0	1.40
				M	M	VF	M	19.0	1.48
	M	F	VF	M	20.0	1.52			

ATR	ISO 10625 								[l/min]
			ID	IDK	AD	TR	ITR		
-02	60 M	VC	C				2.0	0.65	
		UC	VC	C	F	VC	3.0	0.80	
		EC	VC	M	VF	VC	4.0	0.92	
		VC	C	M	VF	VC	5.0	1.03	
		VC	C	M	VF	VC	6.0	1.13	
		VC	M	F	VF	C	7.0	1.22	
		VC	M	F	VF	C	8.0	1.30	
		VC	M	F	VF	C	9.0	1.38	
		VC	M	F	VF	C	10.0	1.45	
		VC	M	F	VF	M	11.0	1.53	
		C	M	F	VF	M	12.0	1.60	
		C	M	F	VF	M	13.0	1.67	
		C	M	F	VF	M	14.0	1.73	
		C	M	F	VF	M	15.0	1.79	
		C	M	F	VF	M	16.0	1.85	
		C	M	F	VF	M	17.0	1.90	
		C	M	F	VF	M	19.0	2.01	
C	M	F	VF	M	20.0	2.07			
-025	60 M	VC					2.0	0.81	
		EC	VC				3.0	0.99	
		VC	VC				4.0	1.15	
		VC	C				5.0	1.28	
		VC	C				6.0	1.40	
		VC	C				7.0	1.52	
		C	M				8.0	1.62	
		C	M				9.0	1.71	
		C	M				10.0	1.81	
		C	M				11.0	1.90	
		C	M				12.0	1.98	
		C	M				13.0	2.06	
		C	M				14.0	2.14	
		M	M				15.0	2.21	
M	M				16.0	2.29			
M	M				17.0	2.36			
M	M				19.0	2.49			
M	F				20.0	2.56			
-03	60 M	VC	C				2.0	0.97	
		EC	VC	C	F		3.0	1.19	
		VC	VC	M	VF		4.0	1.37	
		VC	C	F	VF		5.0	1.53	
		VC	C	F	VF		6.0	1.68	
		VC	M	F	VF		7.0	1.81	
		VC	M	F	VF		8.0	1.94	
		VC	M	F	VF		9.0	2.06	
		VC	M	F	VF		10.0	2.17	
		C	M	F	VF		11.0	2.28	
		C	M	F	VF		12.0	2.38	
		C	M	F	VF		13.0	2.48	
		C	M	F	VF		14.0	2.57	
		C	M	F	VF		15.0	2.66	
		C	M	F	VF		16.0	2.75	
C	M	F	VF		17.0	2.83			
M	F	F	VF		19.0	2.99			
M	F	F	VF		20.0	3.07			
-04	60 M	EC	VC	C	F		2.0	1.29	
		VC	VC	M	VF		3.0	1.58	
		VC	VC	M	VF		4.0	1.82	
		VC	VC	M	VF		5.0	2.04	
		VC	VC	M	VF		6.0	2.23	
		VC	VC	M	VF		7.0	2.41	
		VC	C	F	VF		8.0	2.58	
		VC	C	F	VF		9.0	2.74	
		VC	C	F	VF		10.0	2.88	
		VC	C	F	VF		11.0	3.03	
		VC	M	F	VF		12.0	3.16	
		VC	M	F	VF		13.0	3.29	
		C	M	F	VF		14.0	3.41	
		C	M	F	VF		15.0	3.53	
		C	M	F	VF		16.0	3.65	
C	M	F	VF		17.0	3.76			
C	M	F	VF		19.0	3.98			
C	M	F	VF		20.0	4.08			



The apps for Lechler agricultural nozzles make selection and use of the optimum nozzle even easier. Find out more here: www.lechler.com/de-en/service/apps





Pressure

Nozzle		[bar]
ID	01-06:	2-8-15-20
IDK	0067-06:	2-8-15-20
AD	0067-04:	2-8-15-20
ST	01-20:	1.5-10-30
TR 80	005-05:	3-8-20
TR 60	005-05:	2-8-20
ITR	01-02:	3-10-30
IS	02-06:	
Field sprayer/ underplant sprayer: 2-4-8		
Vertical boom: 2-8-15		
IDKS	015-06:	
Field sprayer/underplant sprayer: 1-1.5-3-6		
Vertical boom: 1-8-15		
OC	2-30:	1.5-2.5-5

Nozzle filter (M = mesh/inch)

General:

60 M

Exceptions:

25 M

ID 05-06, IDK 05-06

ISO 25358 classification according to droplet sizes:

VF	Very fine
F	Fine
M	Medium
C	Coarse
VC	Very coarse
EC	Extremely coarse
UC	Ultra coarse

Subject to modifications.









- Operating pressure at the nozzle (measured with diaphragm valve)
- The stated liter-per-hectare rates apply to water
- Verify the table values by gauging the flow rates prior to every spraying season
- Pay attention to uniform nozzle adjustment

ATR	ISO 10625 								[l/min]				
			ID	IDK	AD	TR	ITR						
-05	25 M			EC					2.0	1.61			
			EC	VC		F			3.0	1.97			
			EC	VC		F			4.0	2.28			
			VC	VC		F			5.0	2.55			
			VC	VC		F			6.0	2.79			
			VC	C		SF			7.0	3.01			
			VC	C		SF			8.0	3.22			
			VC	C		SF			9.0	3.42			
			VC	C		SF			10.0	3.60			
			VC	M		SF			11.0	3.77			
			VC	M		SF			12.0	3.94			
			VC	M		SF			13.0	4.10			
			VC	M		SF			14.0	4.26			
			VC	M		SF			15.0	4.41			
			VC	M		SF			16.0	4.55			
			VC	M		SF			17.0	4.69			
			C	M		SF			19.0	4.96			
			C	M		SF			20.0	5.09			
			-06	25 M			EC					2.0	1.93
						UC	VC					3.0	2.36
EC	VC								4.0	2.73			
EC	VC								5.0	3.05			
VC	VC								6.0	3.34			
VC	C								7.0	3.61			
VC	C								8.0	3.86			
VC	C								9.0	4.09			
VC	M								10.0	4.32			
VC	M								11.0	4.52			
VC	M								12.0	4.72			
VC	M								13.0	4.91			
VC	M								14.0	5.10			
VC	M								15.0	5.28			
VC	M								16.0	5.45			
C	F					17.0	5.62						
C	F					19.0	5.94						
C	F					20.0	6.09						

Spray table

Important information at a glance for underplant treatment







Spray table for air-injector off center nozzles IS

			[l/min]						
									
			2.0	3.0	4.0	5.0	6.0	7.0	8.0
	IS 80-02	60 M	0.49	0.60	0.69	0.77	0.84	0.91	0.97
	IS 80-025	60 M	0.70	0.86	0.90	1.13	1.24	1.34	1.43
	IS 80-03	60 M	0.86	1.05	1.21	1.35	1.48	1.60	1.71
	IS 80-04	60 M	1.11	1.36	1.57	1.75	1.92	2.07	2.21
	IS 80-05	25 M	1.23	1.51	1.74	1.95	2.14	2.31	2.47
	IS 80-06	25 M	1.36	1.67	1.93	2.16	2.37	2.56	2.73

- The stated l/ha values apply to water
- Check the nozzles by gauging the flow rates prior to every spraying season
- Pressure measured at the nozzle

If necessary, please request additional information material for installation instructions for broadcast spraying A100 and banding in orchards and vineyards A200.

Spray table for compact air-injector off center nozzles IDKS











			[l/min]						
									
			1.0	1.5	2.0	3.0	4.0	5.0	6.0
	IDKS 80-015	60 M	–	0.28	0.32	0.39	0.45	0.51	0.55
	IDKS 80-02	60 M	–	0.42	0.48	0.59	0.68	0.76	0.83
	IDKS 80-025	60 M	–	0.56	0.65	0.80	0.92	1.03	1.13
	IDKS 80-03	60 M	0.57	0.70	0.81	0.99	1.15	1.28	1.40
	IDKS 80-04	60 M	0.69	0.84	0.97	1.19	1.37	1.53	1.68
	IDKS 80-05	25 M	0.91	1.12	1.29	1.58	1.82	2.04	2.23
	IDKS 80-06	25 M	1.14	1.39	1.61	1.97	2.28	2.55	2.79



Recommendation

Thanks to its long design, the MultiCap provides optimum protection for IDKS nozzles against damage.

Spray table for off center nozzles OC

			[l/min]				
							
			1.5	2.0	3.0	4.0	5.0
	OC 2	60 M	0.49	0.65	0.80	0.92	1.03
	OC 3	60 M	0.88	1.01	1.24	1.43	1.60
	OC 4	60 M	1.11	1.28	1.56	1.81	2.02
	OC 5	25 M	1.37	1.58	1.94	2.24	2.50
	OC 6	25 M	1.64	1.90	2.32	2.68	3.00
	OC 8	25 M	2.16	2.50	3.06	3.53	3.95
	OC 12	25 M	3.47	4.00	4.90	5.66	6.33
	OC 20	25 M	5.45	6.30	7.71	8.91	9.96
	OC 30	25 M	8.66	10.00	12.25	14.14	15.81



Nozzle calculator app

The apps for Lechler agricultural nozzles make selection and use of the optimum nozzle even easier. Find out more here: www.lechler.com/de-en/service/apps



**ENGINEERING
YOUR SPRAY SOLUTION**



Lechler GmbH · Precision Nozzles · Agricultural Spray Nozzles and Accessories
Ulmer Strasse 128 · 72555 Metzingen, Germany · Phone +49 7123 962-0 · info@lechler.de · www.lechler-agri.com

China: Lechler Nozzle Systems (Changzhou) Co., Ltd. · No.99 Decheng Rd, Jintan, Changzhou, JS 213200, P.R.C · Phone +86 400-004-1879 · info@lechler.com.cn

France: Lechler France SAS · Parc de la Haute Maison · 6, Allée Képler, Bâtiment C2 · 77420 Champs-sur-Marne · Phone +33 1 49882600 · info@lechler.fr

India: Lechler (India) Pvt. Ltd. · Plot B-2 · Main Road · Wagle Industrial Estate Thane · 400604 Maharashtra · Phone +91 22 40634444 · lechler@lechlerindia.com

Italy: Lechler Spray Technology S.r.l. · Via Don Dossetti, 2 · 20074 Carpiano (Mi) · Phone +39 02 98859027 · info@lechleritalia.com

Spain: Lechler, S.A. · C / Isla de Hierro, 7 – Oficina 1.3 · 28703 San Sebastián de los Reyes (Madrid) · Phone +34 91 6586346 · info@lechler.es



Edition 10/2023 · EN · PDF · www.dgm-kommunikation.de
Subject to technical modifications or mistakes.