

ENGINEERING  
YOUR SPRAY SOLUTION



NEW



# FULL CONE NOZZLE HelixFlow

Series 4Fx

GENERAL INDUSTRY

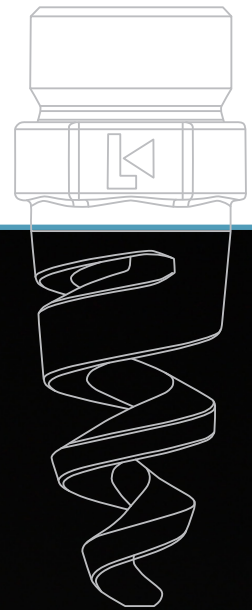

# Full cone nozzles

## Series 4Fx



### Features:

- Fine droplet sizes
- Low weight
- Robust design
- Maintenance free

### Applications:

- General Industry
- Flue gas desulphurization (special material)
- General cooling
- General gas humidification

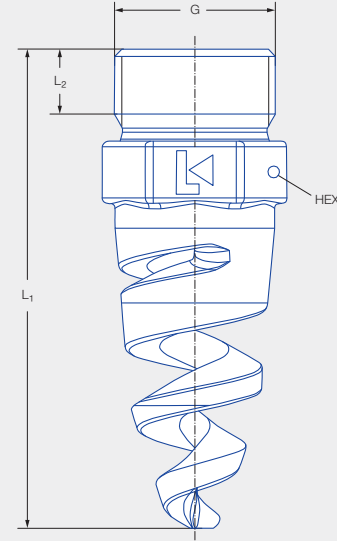
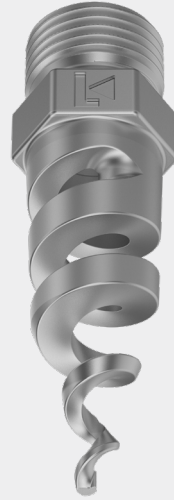

Series 4Fx

Male thread

### Technical data:



**Maximum operating temperature**  
300 °C  
(depending on the material, higher temperatures are also possible)



**Material**  
Stainless steel 316L, other materials on request







**Recommended operating pressure**  
2 bar (Design pressure), max. 10 bar



**Nozzle connection**  
Male thread to BSPP, external thread to BSPT or NPT possible on request

Spray angle	Ordering no.			Narrowest free cross section Ø [mm]	V̇ Water						G	L <sub>1</sub> [mm]	L <sub>2</sub> [mm]	Flat	Weight [g]	Spray width [m]	
	Type	1Y	Code		p [bar]											H = 500	H = 1000
					0.3	0.5	1.0	2.0	5.0	10.0							
60° 	4F5.254	●	AK	6.0	51	66	93	132	209	295	3/4	95	11.8	27	106	0.6	0.8
	4F5.334	●	AM	7.0	82	106	150	212	335	474	1	123	12.6	34	214	0.6	1.0
	4F5.354	●	AM	7.0	91	118	167	236	373	528	1	123	12.6	34	214	0.6	1.0
	4F5.394	●	AM	7.0	116	150	212	300	474	671	1	123	12.6	34	187	0.6	1.0
	4F5.454	●	AR	9.0	165	213	301	425	672	950	1 1/2	153	16.6	50	573	0.8	1.2
	4F5.504	●	AR	10.0	217	280	396	560	885	1252	1 1/2	153	16.6	50	529	0.6	1.0
	4F5.524	●	AR	11.0	244	315	445	630	996	1409	1 1/2	153	16.6	50	528	0.8	1.2
	4F5.584	●	AV	20.0	349	450	636	900	1423	2012	2	203	18.6	60	959	0.8	1.2
	4F5.614	●	AV	24.0	434	560	792	1120	1771	2504	2	203	18.6	60	892	0.8	1.2

Spray angle	Ordering no.			Narrowest free cross section Ø [mm]	V̇ Water						G	L <sub>1</sub> [mm]	L <sub>2</sub> [mm]	Flat	Weight [g]	Spray width [m]	
	Type	1Y	Code		p [bar]											H = 500	H = 1000
		Stainless steel 316L	BSPP		0.3	0.5	1.0	2.0	5.0	10.0							
90° 	4F5.166	●	AG	4.5	31	40	57	80	126	179	1/2	65	9.8	22	78	0.9	1.4
	4F5.216	●	AG	4.5	41	53	75	106	168	237	1/2	65	9.8	22	75	0.8	1.6
	4F5.256	●	AK	7.0	51	66	93	132	209	295	3/4	80	11.8	27	106	0.9	1.8
	4F5.336	●	AM	7.0	82	106	150	212	335	474	1	110	12.6	34	237	1.0	2.0
	4F5.396	●	AM	8.0	116	150	212	300	474	671	1	110	12.6	34	220	1.0	2.0
	4F5.456	●	AR	11.0	165	213	301	425	672	950	1 1/2	125	16.6	50	478	0.9	1.8
	4F5.506	●	AR	12.0	217	280	396	560	885	1252	1 1/2	125	16.6	50	442	1.0	1.6
	4F5.526	●	AR	12.0	244	315	445	630	996	1409	1 1/2	125	16.6	50	423	0.8	1.4
	4F5.586	●	AV	15.0	349	450	636	900	1423	2012	2	176	18.6	60	978	1.2	2.2
	4F5.616	●	AV	15.0	434	560	792	1120	1771	2504	2	176	18.6	60	900	1.2	2.0
120° 	4F5.218	●	AG	5.0	41	53	75	106	168	237	3/8	65	9.8	22	50	1.4	2.4
	4F5.258	●	AK	6.0	51	66	93	132	209	295	3/4	80	11.8	27	109	1.6	2.6
	4F5.338	●	AM	7.0	82	106	150	212	335	474	1	110	12.6	34	248	1.6	3.2
	4F5.398	●	AM	9.0	116	150	212	300	474	671	1	110	12.6	34	227	1.8	2.6
	4F5.458	●	AR	12.0	165	213	301	425	672	950	1 1/2	130	16.6	50	561	1.4	2.4
	4F5.508	●	AR	12.0	217	280	396	560	885	1252	1 1/2	130	16.6	50	530	2.0	3.0
	4F5.528	●	AR	12.0	244	315	445	630	996	1409	1 1/2	130	16.6	50	510	1.6	2.6
	4F7.588	●	AV	12.0	349	450	636	900	1423	2012	2	191	18.6	60	1058	1.6	2.8
	4F7.618	●	AV	13.0	434	560	792	1120	1771	2504	2	191	18.6	60	986	1.8	2.8
150° 	4F7.339	●	AM	8.0	82	106	150	212	335	474	1	115	12.6	34	258	2.2	4.2
	4F7.399	●	AM	8.0	116	150	212	300	474	671	1	115	12.6	34	237	2.2	4.2
170° 	4F7.250	●	AK	6.0	51	66	93	132	209	295	3/4	95	11.8	27	120	3.0	5.4
	4F7.330	●	AM	8.0	82	106	150	212	335	474	1	119	12.6	34	272	4.0	6.0
	4F7.390	●	AM	8.0	116	150	212	300	474	671	1	119	12.6	34	253	4.0	6.0
	4F7.450	●	AR	10.0	165	213	301	425	672	950	1 1/2	154	16.6	50	642	2.8	4.4
	4F7.500	●	AR	10.0	217	280	396	560	885	1252	1 1/2	154	16.6	50	604	3.4	4.8
	4F7.520	●	AR	10.0	244	315	445	630	996	1409	1 1/2	154	16.6	50	585	3.4	4.4

Ordering example: Type 4F5.334 + Material 1Y + Connection AM = Order no. 4F5.334.1Y.AM

Conversion formula for this series:  $\dot{V}_2 = \dot{V}_1 \cdot \sqrt{\frac{p_2}{p_1}}$

**ENGINEERING  
YOUR SPRAY SOLUTION**



**Lechler GmbH · Precision Nozzles · Nozzle Systems**  
**Ulmer Strasse 128 · 72555 Metzingen, Germany · Phone +49 7123 962-0 · info@lechler.de · www.lechler.com**

Edition 03/24 · EN · PDF  
Subject to technical modifications or mistakes.