

» ACCESSORIES

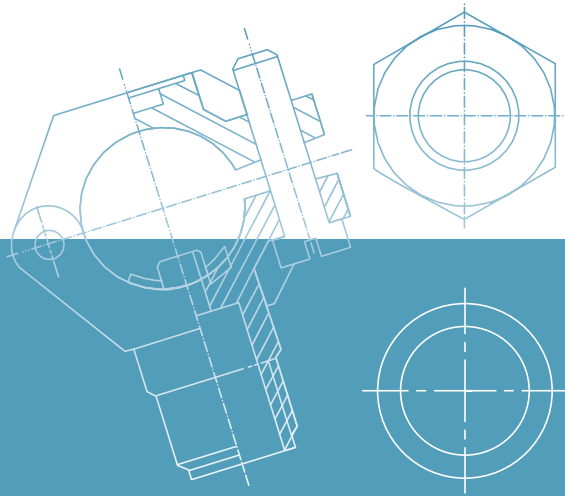

NOZZLE FASTENING ASSEMBLING OPTIONS FOR ALL PURPOSES



Assembly accessories for nozzles without thread or with female thread

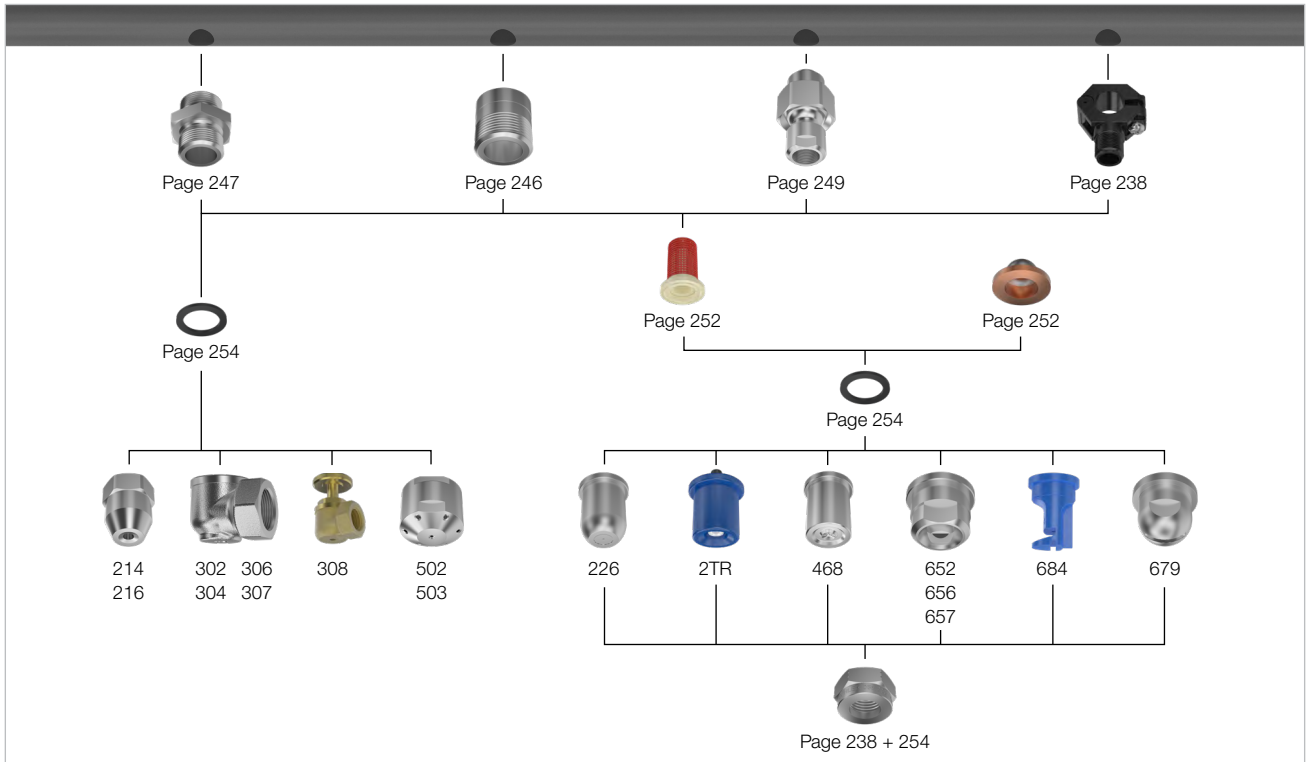

Bayonet quick-release system for nozzles without thread or with bayonet connection

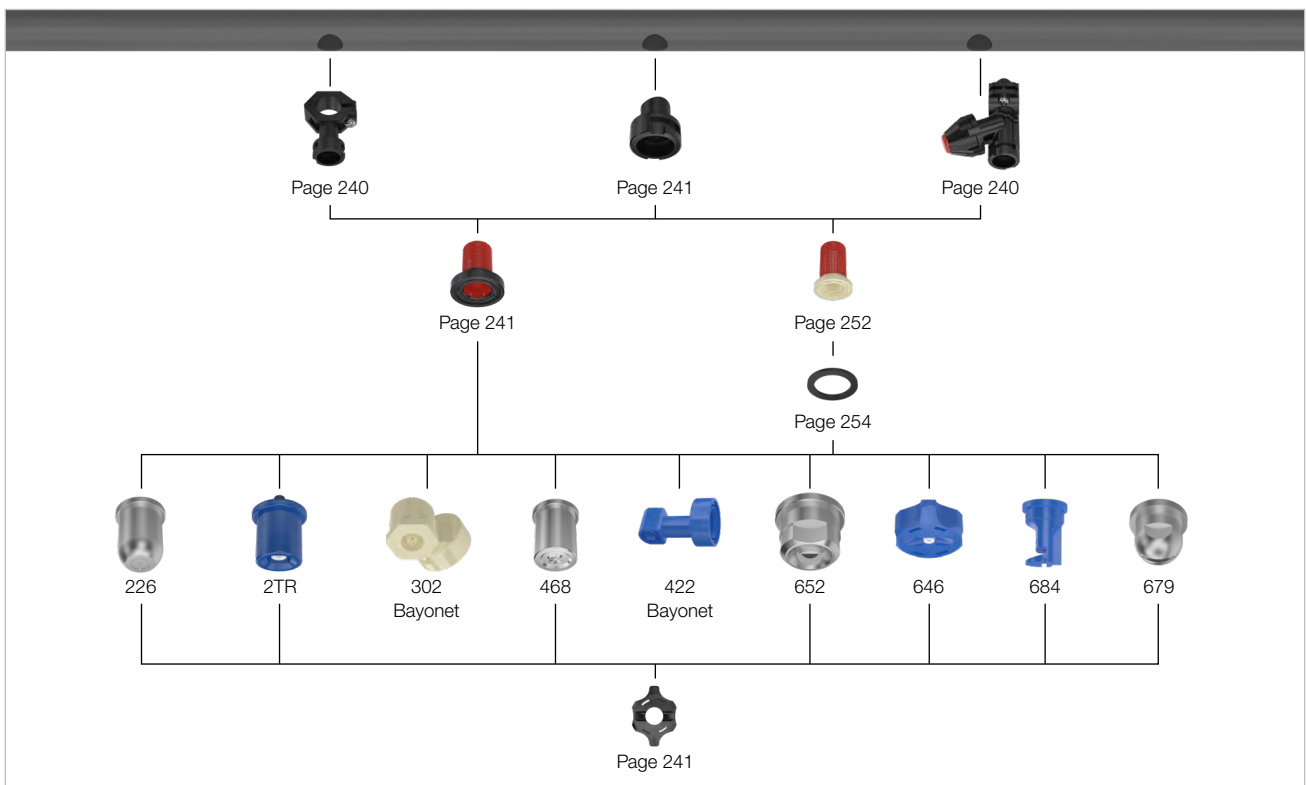

Bayonet quick-release system with ball joint for nozzles with male thread

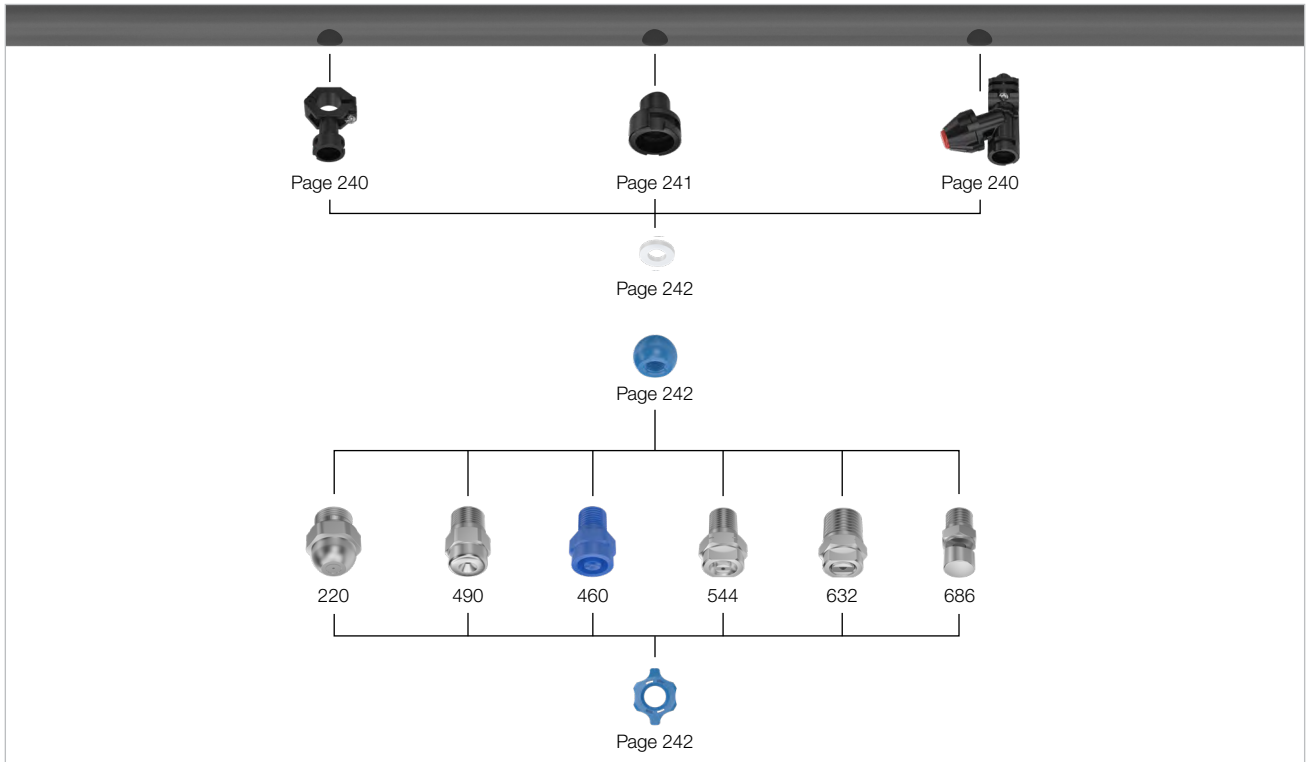

Assembly accessories for nozzles with male thread

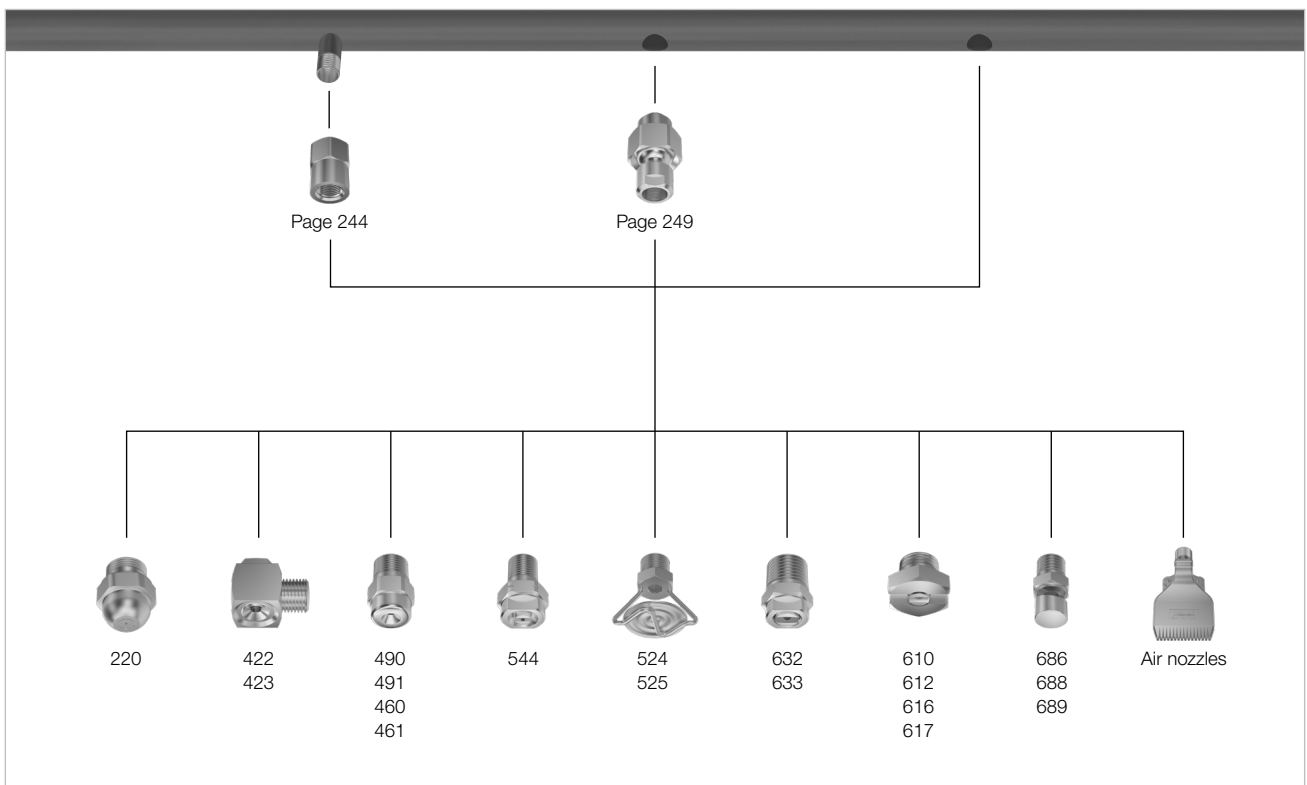



Assembly accessories for nozzles with dovetail version

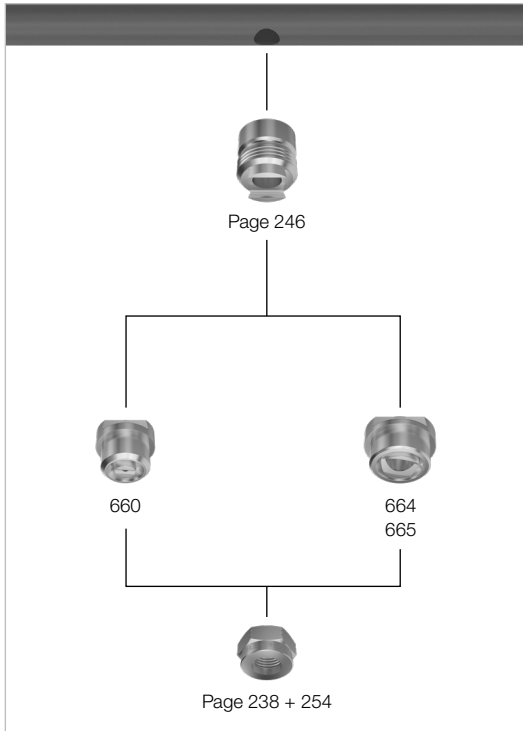

Assembly accessories for nozzles with integrated ball joint

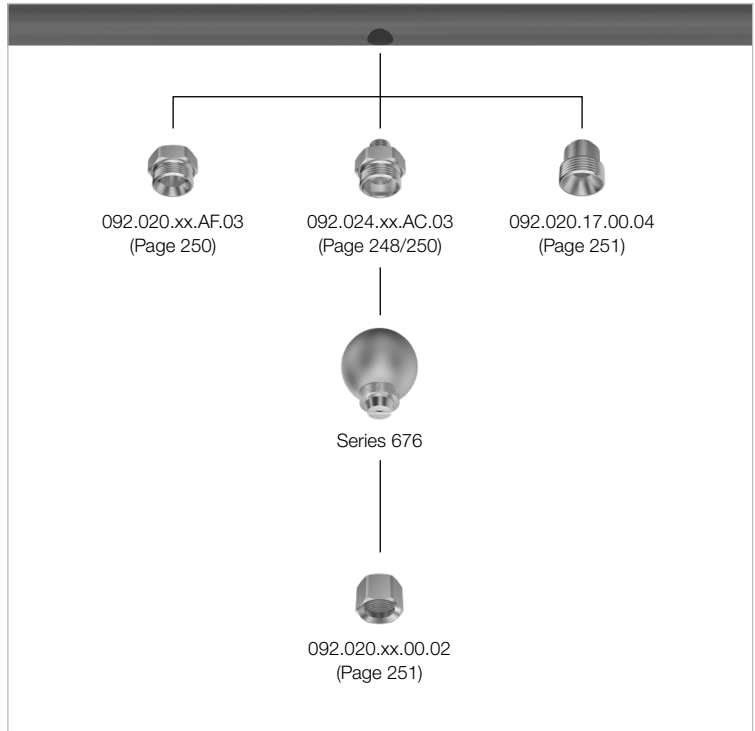

TWISTLOC quick-release system for nozzles without thread

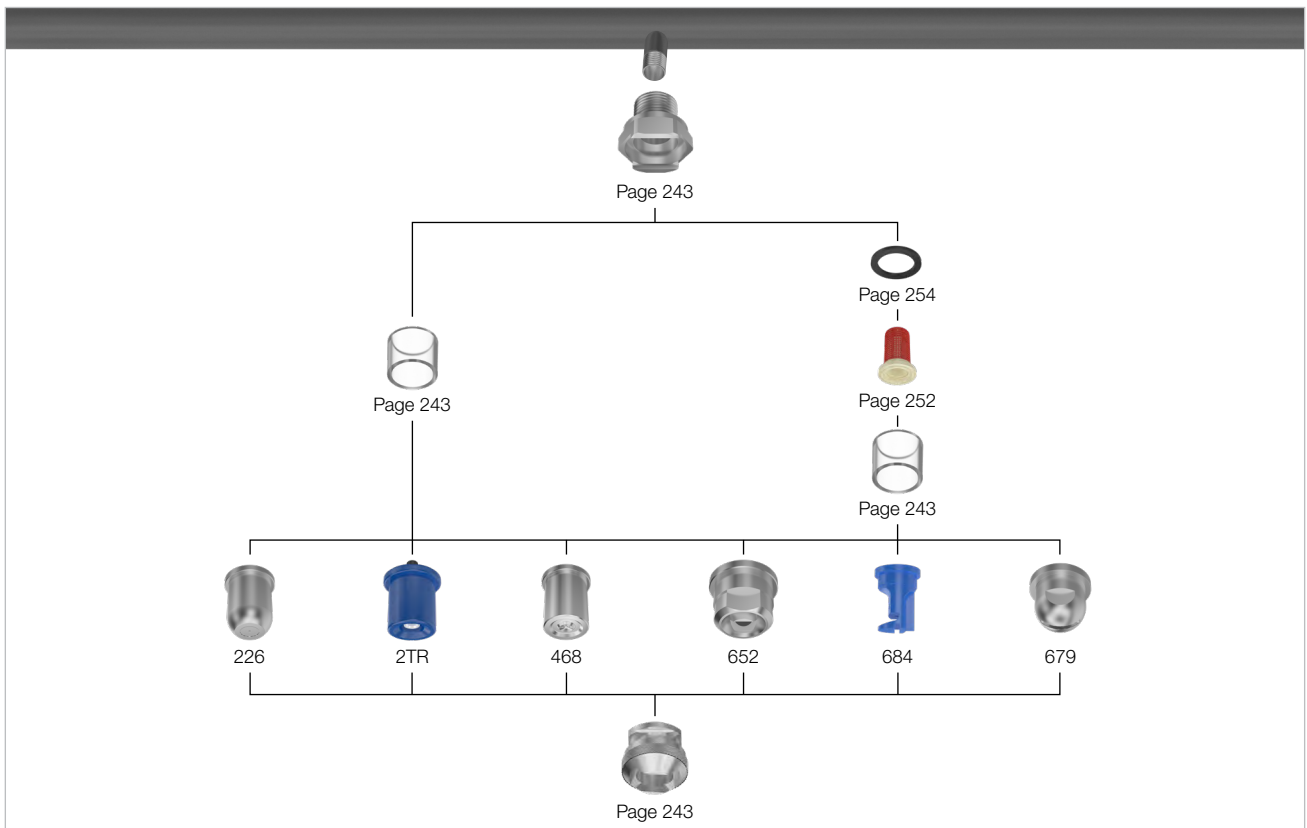

MEMOSPRAY/Easy-Clip combination options

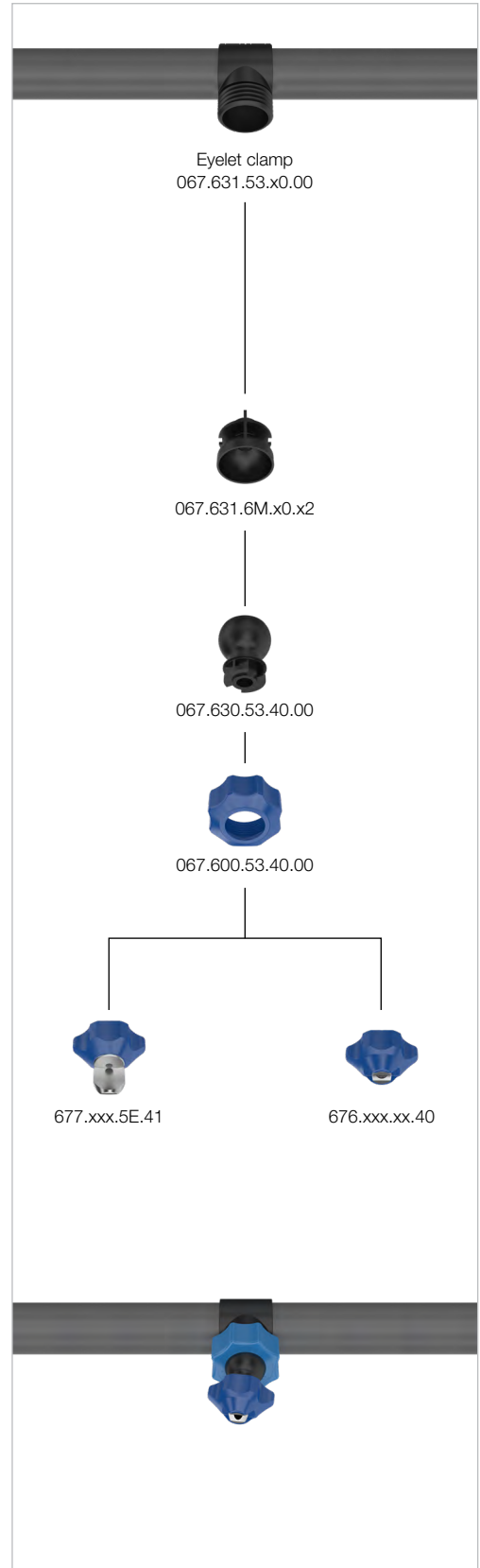
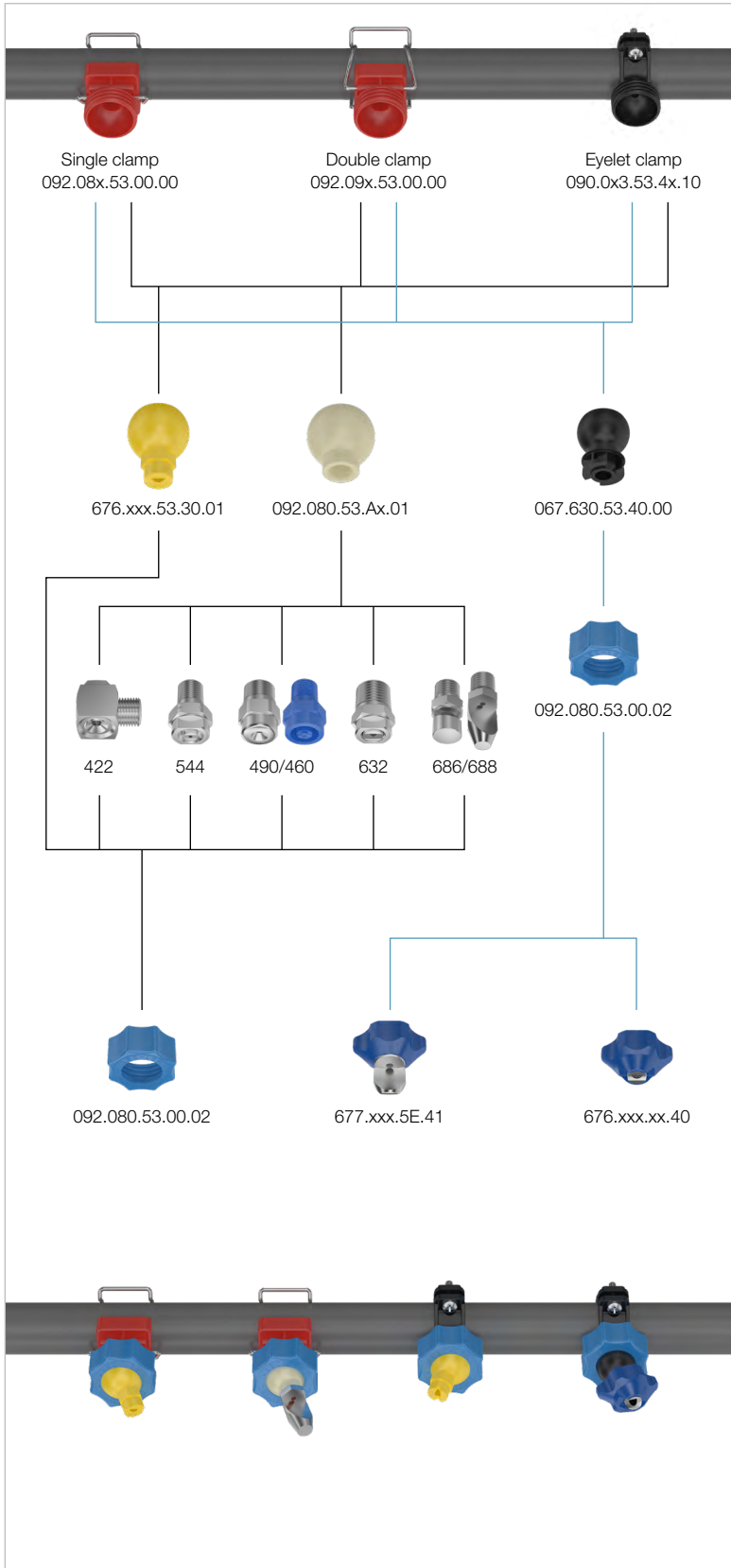

Eyelet clamps with male thread

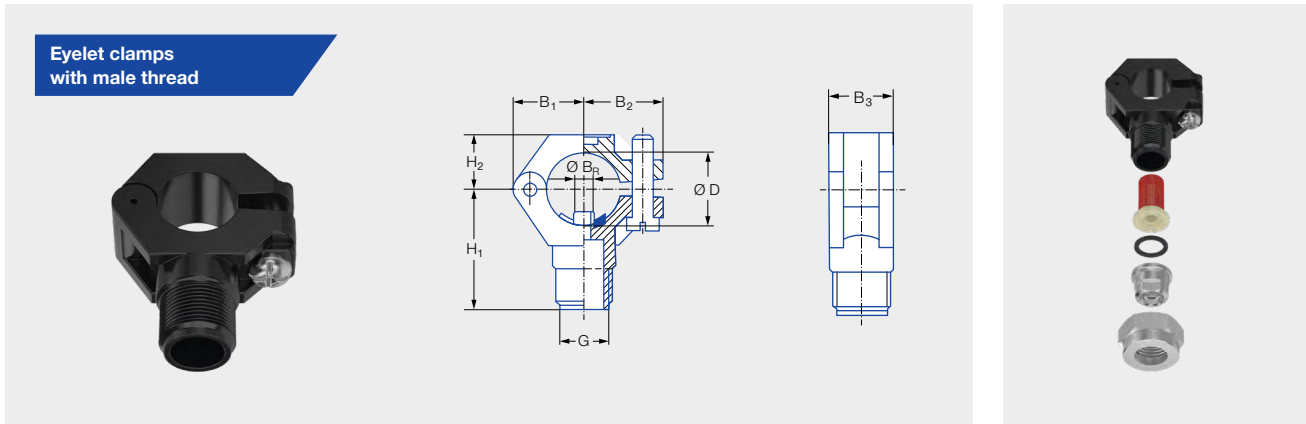

Series	Ordering no.			Screw (material)	G BSPP	Pipe Ø	Dimensions [mm]							Weight [g] (polyamide)		
	Type	Mat. no.					B ₁	B ₂	B ₃	H ₁	H ₂	Ø B _R ¹	Ø B ²		Ø D	
		51 Black	53 White													5E Blue
		Polyamide	Polypropylene	PVDF												
226/2TR/ 216/302/ 308/350/468/ 652/679/684	090.053	●	●	●	Stainless steel 304	3/8	3/8"	19.0	22.0	18.5	34.5	14.5	6.0	6.2-6.4	16.5-18.0	20.0
	090.003	●	●	●		3/8	1/2"	21.2	23.8	18.5	36.5	16.5	6.0	6.2-6.4	20.0-22.0	20.0
	090.013	●	●	●		3/8	3/4"	24.5	26.5	22.0	39.5	17.5	7.6	7.8-8.0	25.0-27.5	25.0
	090.023	●	●	●		3/8	1"	30.0	31.0	22.0	44.0	21.0	10.6	10.8-11.0	32.0-34.5	32.0
	090.033	●	●	●		3/8	1 1/4"	34.0	35.5	25.0	48.0	25.0	12.6	12.8-13.0	40.0-43.0	38.0

¹ Ø B_R = spigot diameter.

² Ø B = recommended bore diameter.

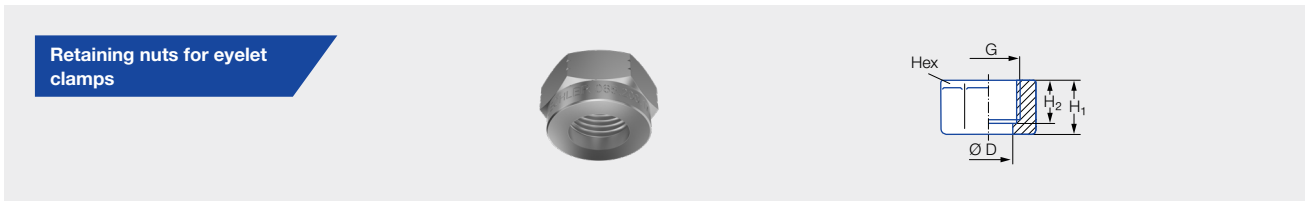

Series	Ordering no.					G BSPP	Dimensions [mm]				Weight [g]	
	Type	Mat. no.					H ₁	H ₂	Ø D	Hex		
		16	17 ¹	30	56 Black							5E Blue
		Stainless steel 303	Stainless steel 316Ti	Brass	POM	PVDF						
226/2TR/ 468/548/ 652/660/679/ 684	065.200	●	●	●			3/8	13.0	10.0	12.8	22	25.0 (Brass)
	065.200				●	●	3/8	14.5	11.5	12.8	22	5.0 (PVDF)

¹ We reserve the right to supply material 316Ti or 316L under material no. 17.

Ordering Type + Material no. = Ordering no.
example: 090.053 + 51 = 090.053.51

Strainers and ball-type non-return valves can be found on Page 252/253.

Eyelet clamps with female thread



Eyelet clamps with female thread

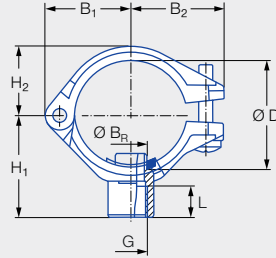

For all nozzles with	Ordering no.						Screw (material)	Pipe Ø	Dimensions [mm]							Weight [g] (polyamide)		
	Type	Mat. no.			Code				B ₁	B ₂	B ₃	H ₁	H ₂	L	Ø B _R ¹		Ø B ²	Ø D
		51 Black	53 White	5E Blue	1/8 BSPP	1/4 BSPP												
Male thread 1/8 BSPP 1/4 BSPP	090.100	●	●	●	AB	AD	Stainless steel 316	3/8"	20.0	23.0	18.5	28.0	14.0	12.0	6.0	6.2-6.4	16.5-18.0	18.0
	090.110	●	●	●	AB	AD		1/2"	22.0	25.0	18.5	31.0	16.0	12.0	6.0	6.2-6.4	20.0-22.0	19.0
	090.120	●	●	●	AB	AD		3/4"	25.0	28.0	22.0	33.0	19.0	12.0	7.6	7.8-8.0	25.0-27.5	24.0
	090.130	●	●	●	AB	AD		1"	30.0	33.0	22.0	36.0	23.0	12.0	10.6	10.8-11.0	32.0-34.5	34.0
	090.140	●	●	●	AB	AD		1 1/4"	34.0	37.0	25.0	40.0	28.0	12.0	12.6	12.8-13.0	40.0-43.0	39.0

¹ Ø B_R = spigot diameter.
² Ø B = recommended bore diameter.

Ordering Type + Material no. + Code = Ordering no.
 example: 090.100 + 51 + AB = 090.100.51.AB

Eyelet clamps with bayonet connection

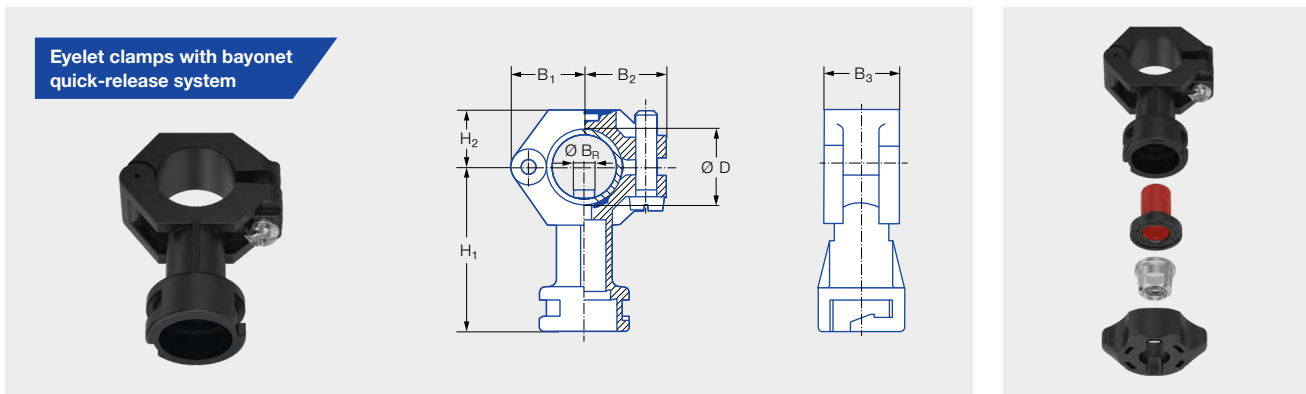

Series	Ordering no.				Screw (material)	Pipe Ø	Dimensions [mm]							Weight [g] (Polyamide)		
	Type	Mat. no.					Code	B ₁	B ₂	B ₃	H ₁	H ₂	Ø B _R ¹		Ø B ²	Ø D
		51 Black Polyamide	53 White Polypropylene	5E Blue PVDF												
226/2TR/ 302 bayonet/ 422 bayonet/ 468/652/646/ 684/679	090.003	●	●	●	KA	Stainless steel 304	1/2"	21.2	23.8	18.5	49.5	16.5	6.0	6.2–6.4	20.0–22.0	22.0
	090.013	●	●	●	KA		3/4"	24.5	26.5	22.0	52.5	17.5	7.6	7.8–8.0	25.0–27.5	26.0
	090.023	●	●	●	KA		1"	30.0	31.0	22.0	57.0	21.0	10.6	10.8–11.0	32.0–34.5	32.0

¹ Ø B_R = spigot diameter.
² Ø B = recommended bore diameter.

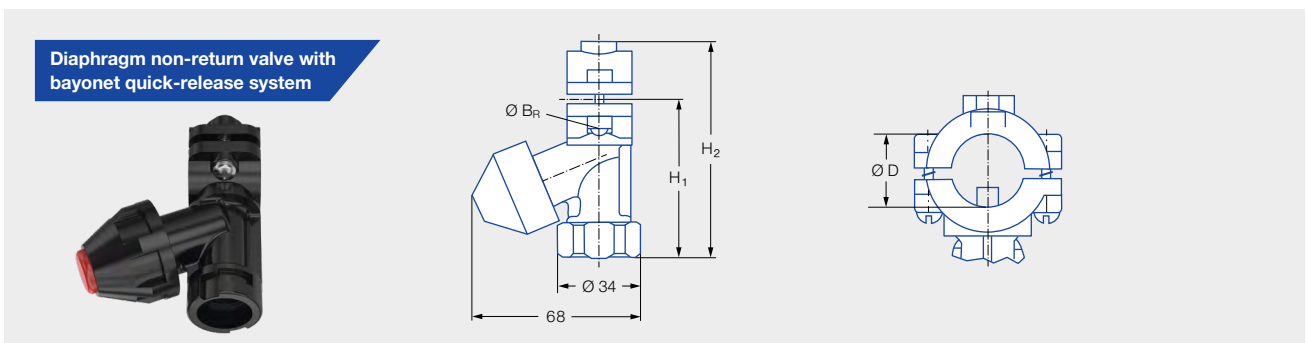

Series	Ordering no.			Screw (material)	Pipe Ø	Ø D [mm]	Pressure [bar]		Dimensions [mm]				Weight [g]	
	Type	Mat. no.					Code	Opening pressure	Closing pressure	H ₁	H ₂	Ø B _R ¹		Ø B ²
		56 Black	POM											
226/2TR/ 302 bayonet/ 422 bayonet/ 468/652/646/ 684/679	065.272	●		KH	Stainless steel 303	1/2"	20.0–22.0	0.8	0.6	59.0	84.0	6.0	6.2–6.4	48.0
	065.272	●		KL		3/4"	25.0–27.5	0.8	0.6	66.0	90.0	9.6	9.8–10.0	53.0

¹ Ø B_R = spigot diameter.
² Ø B = recommended bore diameter.

Material	Max. temperature [°C]	Max. pressure [bar]
PA, PP, PVDF, POM	65	10
PA, PP, PVDF, POM	80	8
PVDF	100	4

Notice: Please consider the material combination when using bayonet eyelet clamps with bayonet quick-release system nuts. The nuts may be difficult to turn when using different materials.

Accessories for bayonet system



Bayonet welded nipple

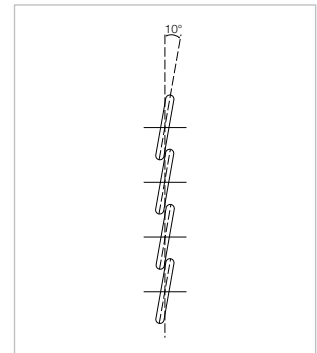
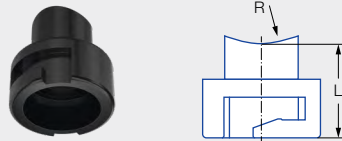

Series	Ordering no.			Dimensions [mm]		Weight [g]
	Type	Mat. no.		L	R	
		50	53			
226/2TR/302 bayonet/ 422 bayonet/468/ 652/646/684/679	095.016.xx.08.05 ¹	PVC	Polypropylene	25.0	16.0	10.0

Twist angle to the right in relation to the pipe axis. Twist angle 10°. Other twist angles available on request.

¹ Replace "xx" with the desired material no.

Strainer with gasket

Suitable for bayonet quick-release system nuts 065.202

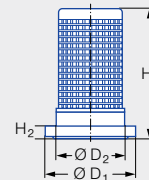

Performance size	Ordering no.		Colour	Dimensions [mm]					Weight [g]
	Type	Mat. no.		Mesh size	H ₁	H ₂	Ø D ₁	Ø D ₂	
		7J							
xxx.32x-xxx.44x	065.268	POM/Santoprene	Blue	0.25	19.20	3.00	18.00	12.00	2.00
xxx.48x-xxx.56x	065.269	POM/Santoprene	Red	0.65	19.20	3.00	18.00	12.00	2.00

Bayonet quick-release system nuts

Incl. gasket 065.242.73 (material: Rubber)

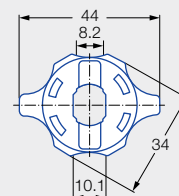

Series	Ordering no.			Colour	Weight [g]
	Type	Mat. no.			
		POM	Polypropylene		
652/679	065.202.56.00			Red	10.0
	065.202.53.00			Grey	10.0
	065.202.5E.00			Blue	10.0

Bayonet quick-release system nuts

Incl. gasket 065.242.73 (material: Rubber)

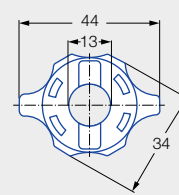

Series	Ordering no.		Colour	Weight [g]
	Type	Mat. no.		
		POM		
226/2TR/ 468/684	065.202.56.11		Black	10.0
	065.202.53.11		Grey	10.0

Notice: Please consider the material combination when using bayonet eyelet clamps with bayonet quick-release system nuts. The nuts may be difficult to turn when using different materials.



Ball joints for bayonet quick-release system

Ball joint system for nozzles with 1/8" and 1/4" male thread.

Ball joint for eyelet clamps with bayonet quick-release system

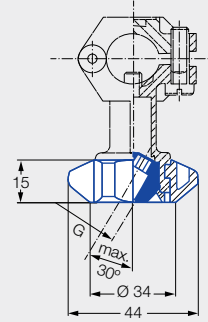

For all nozzles with 1/8" or 1/4" male thread	Ordering no.				Colour	Weight [g]
	Type	Mat. no.	Code			
		PVDF	1/8 BSPP	1/4 BSPP		
Ball joint	092.150	5E	AB	AD	Blue	5.0

Bayonet quick-release system nut for ball joint

Incl. O-ring
Ordering no. 095.015.7C.04.16.0
(material: 72 NBR 872)

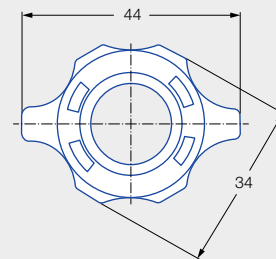

For all nozzles with 1/8" or 1/4" male thread	Ordering no.			Colour	Weight [g]
	Type	Mat. no.			
		PVDF			
Quick-release system nut	092.150.5E.00	●		Blue	28.0

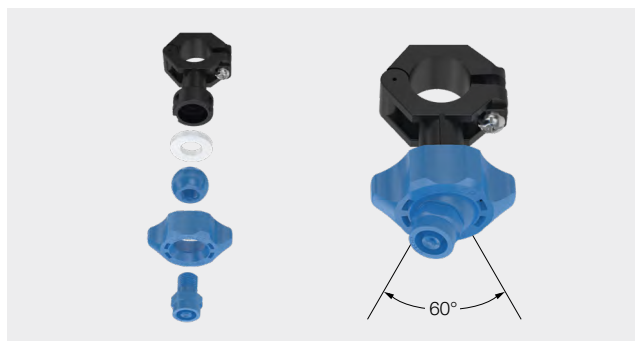

Max. temperature [°C]	Max. pressure [bar]
65	10
80	8
100	4

Ordering Type + Material no. + Code = Ordering no.
example: 092.150 + 5E + AB = 092.150.5E.AB

» TWISTLOC

Quick-change nozzle system



Lechler TWISTLOC, nozzle changing in less than no time.
Save time and money with the quick-change nozzle system.

- **Quick:**
It takes just one twist to install or remove the nozzle.
- **Easy:**
Can be installed without tools – even in difficult-to-access locations and in bad lighting conditions.
- **Safe:**
Installation errors are avoided, as the nozzles are always set to the correct direction.
- **Max. pressure:**
15 bar.

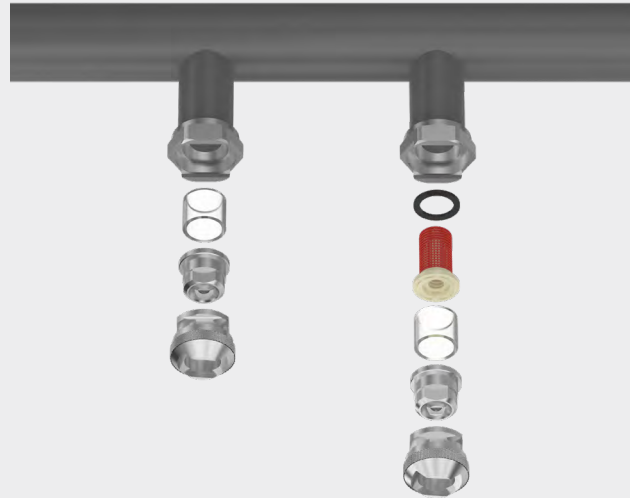

System components		Ordering no.							Inner Ø D [mm]	Weight [g]	
		Type	Mat. no.				Code				
			1C	16	5E	7A	1/4 BSPT	3/8 BSPT			Welded connection
Threaded nipple		092.102	•				CC		8.0	25.0	
		092.102	•					CE	11.6	25.0	
		092.102			•				CE	8.0	10.0
Welded nipple		092.104	•					00	11.6	45.0	
Gasket for material 304 SS and 303 SS		092.113				•			–	1.0	
Gasket for material PVDF		092.115				•			–	1.0	
Gasket, incl. rubber gasket ring for use with non-return valves or strainers		092.116				•			–	2.0	
Gasket, incl. rubber gasket ring for use with non-return valves or strainers, for PVDF material		092.114				•			–	2.0	
Quick-release system For nozzle series 652/679		092.106	•	•					–	20.0 (stainless steel)	
Quick-release system For nozzle series 226/468/684		092.108	•	•					–	20.0 (stainless steel)	



Non-return valves, strainers
For installation in nipples with inner Ø 11.6 mm (see Page 252/253).

Ordering Type + Material no. + Code = Ordering no.
example: 092.102 + 16 + CC = 092.102.16.CC



Sockets

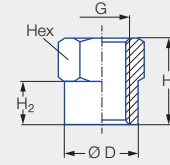
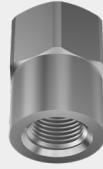

For all nozzles with	Ordering no.				G BSPP	Dimensions [mm]				Weight [g] (Brass)	
	Type	Mat. no.				H ₁	H ₂	Ø D	Hex		
		1Y	17	30							53
1/8" male thread	040.270	●		●		1/8	20.0	10.0	13.8	14	20.0
1/4" male thread	061.220	●		●		1/4	20.0	10.0	16.8	17	20.0
3/8" male thread	040.271	●		●		3/8	20.0	10.0	21.8	22	25.0
	040.271				●	3/8	20.0	11.0	25.0	22	25.0
1/2" male thread	040.272		●	●		1/2	30.0	15.0	26.5	27	70.0
3/4" male thread	061.620		●	●		3/4	40.0	20.0	31.5	32	108.0

Notice: Sockets are also suitable for welding.

Sockets with radius

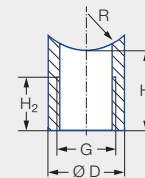

For all nozzles with	Ordering no.		G BSPP	Dimensions [mm]			Weight [g]
	Type	Mat. no.		H ₁	H ₂	Ø D	
		1Y					
1/4" male thread	040.228.1Y.yy ¹	●	1/4	18.0	12.0	17.0	16.0

¹ Replace "yy" with the desired radius R (R = 10/13/16/20/25 or 31 mm).

Ordering Type + Material no. = Ordering no.
 example: 040.270 + 1Y = 040.270.1Y

Sockets

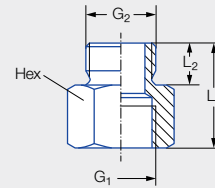

Connection components	Ordering no.			G ₁ BSPP	G ₂ BSPP	Dimensions [mm]			Weight [g] (Brass)
	Type	Mat. no.				L ₁	L ₂	Hex	
		17 Stainless steel 316Ti	30 Brass						
1/8" to 3/8"	040.211	●	●	1/8	3/8	20.0	10.0	22	40.0
1/4" to 3/8" short	065.221	●	●	1/4	3/8	23.0	10.0	22	40.0
1/4" to 3/8" long	065.228	●	●	1/4	3/8	36.0 ¹	14.0	19	45.0
3/8" to 3/8"	065.220	●	●	3/8	3/8	25.0	10.0	22	40.0
3/4" to 3/4"	065.620	●	●	3/4	3/4	35.0	14.0	32	280.0

¹ Mounting of nozzle filters and ball-type non-return valves possible (see Page 252/253).

Reduction socket

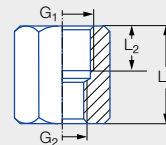
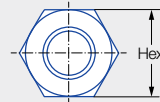
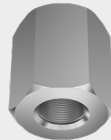

Connection components	Ordering no.			G ₁ BSPP	G ₂ BSPP	Dimensions [mm]			Weight [g]
	Type	Mat. no.				L ₁	L ₂	Hex	
		1Y Stainless steel 316L	30 Brass						
3/8" to 1/4"	095.019.30.00.23		●	3/8	1/4	26.0	12.0	22	55.0

Ordering Type + Material no. = Ordering no.
example: 040.211 + 17 = 040.211.17



Welded nipple with dovetail guide

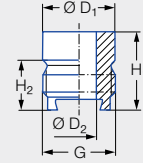

Series	Ordering no.				G BSPP	Dimensions [mm]				Weight [g]
	Type	Mat. no.				H ₁	H ₂	Ø D ₁	Ø D ₂	
		17	Stainless steel 316Ti							
660	066.011	●			3/8	18.0	11.5	16.5	8.0	21.0
664/665	066.410	●			3/4	27.0	15.5	28.0	14.0	65.0

Welded nipple

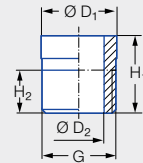

Series	Ordering no.					G BSPP	Dimensions [mm]				Weight [g] (Brass)
	Type	Mat. no.					H ₁	H ₂	Ø D ₁	Ø D ₂	
		02	17	30	53						
226/216/2TR/302/308/350/ 468/652/684/548/679	065.210	●	●	●	●	3/8	18.0	10.0	17.2	11.6	20.0
306/307/502/ 503/656/657	065.610	●	●		●	3/4	27.0	14.0	28.0	18.0	61.0

Ordering Type + Material no. = Ordering no.
 example: 066.011 + 17 = 066.011.17

Welded nipple with radius

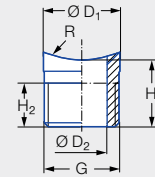

Series	Ordering no.		G BSPP	Dimensions [mm]				Weight [g]
	Type	Mat. no.		H ₁	H ₂	Ø D ₁	Ø D ₂	
		17						
		Stainless steel 316Ti						
226/216/2TR/302/308/350/468/652/684/548/679	065.217.17.yy¹	●	3/8 A	15.0	10.0	17.2	11.5	20.0
306/307/502/503/656/657	065.612.17.yy¹	●	3/4 A	23.0	14.0	28.0	18.0	61.0

¹ Replace "yy" with the desired radius R (R = 10/13/16/20/25 or 31 mm).

Double nipple

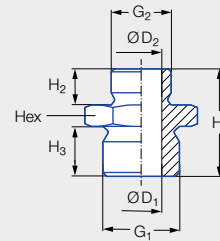

Series	Ordering no.			G ₁ BSPP	G ₂ BSPP	Dimensions [mm]					Weight [g] (Brass)	
	Type	Mat. no.				H ₁	H ₂	H ₃	Ø D ₁	Ø D ₂		Hex
		17	30									
		Stainless steel 316Ti	Brass									
226/216/2TR/302/308/350/468/652/684/548/679	065.215¹	●	●	3/8	1/4	25.0	10.0	10.0	10.0	7.0	22	30.0
	065.215.xx.02²	●	●	3/8	1/4	35.0	10.0	10.0	11.6	7.0	22	32.0
	065.211	●	●	3/8	3/8	25.0	10.0	10.0	11.5	–	22	25.0
	065.211.xx.04²	●	●	3/8	1/2	30.0	10.0	14.0	11.5	–	27	62.0
306/307/502/503/656/657	065.611	●	●	3/4	3/4	35.0	14.0	14.0	18.0	–	32	90.0

¹ Not to be used with non-return valve or strainer.

² Replace "xx" with the desired material no.

Ordering Type + Material no. = Ordering no.
 example: 065.217.17.yy + 17 = 065.217.17.yy.17

Ball joints with threaded connection



Ball joints with female thread

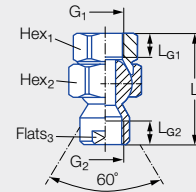

For all nozzles with	Ordering no.				G ₁ BSPP	G ₂ BSPP	Dimensions [mm]						Weight [g] (Brass)
	Type	Mat. no.		Code			L	L _{G1}	L _{G2}	Hex ₁	Hex ₂	Flats	
		16 Stainless steel 303	30 Brass										
1/8" male thread	092.010	●	●	AB	1/8	1/8	43.1	8.0	8.0	22	24	13	110.0
1/4" male thread	092.020	●	●	AD	1/4	1/4	60.3	12.0	11.5	27	27	17	200.0
	092.021	●	●	AF	3/8	1/4	58.3	12.0	11.5	27	27	17	160.0
3/8" male thread	092.030	●	●	AF	3/8	3/8	56.0	12.0	12.0	27	30	19	185.0
1/2" male thread	092.040	●	●	AH	1/2	1/2	71.0	15.5	15.5	36	41	24	425.0
3/4" male thread	092.050	●	●	AL	3/4	3/4	80.0	17.0	17.0	41	46	30	595.0

Ball joints with male thread

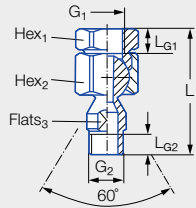

Series	Ordering no.				G ₁ BSPP	G ₂ BSPP	Dimensions [mm]						Weight [g] (Brass)
	Type	Mat. no.		Code			L	L _{G1}	L _{G2}	Hex ₁	Hex ₂	Flats	
		16 Stainless steel 303	30 Brass										
226/216/2TR/ 302/308/350/ 468/652/684/ 548/679	092.022	●	●	AD	1/4	3/8	64.0	12.0	10.0	27	27	17	135.0
	092.022	●	●	AF	3/8	3/8	62.0	12.0	10.0	27	27	17	165.0

Compact ball joints

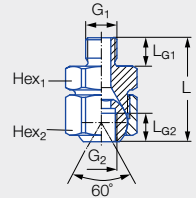

For all nozzles with	Ordering no.				G ₁ BSPP	G ₂ BSPP	Dimensions [mm]						Weight [g] (Brass)
	Type	Mat. no.		Code			L	L _{G1}	L _{G2}	Hex ₁	Hex ₂		
		16 Stainless steel 303	30 Brass										
1/8" male thread	092.010	●	●	AA	1/8	1/8	29.3	8.0	8.0	22	24	70.0	
1/4" male thread	092.024	●	●	AC	1/4	1/4	44.0	12.0	12.0	27	27	140.0	
3/8" male thread	092.030	●	●	AE	3/8	3/8	44.0	12.0	12.0	27	30	160.0	

Ordering Type + Material no. + Code = Ordering no.
 example: 092.010 + 16 + AB = 092.010.16.AB

Ball joints with welding connection and female thread



Ball joints with welding connection and female thread

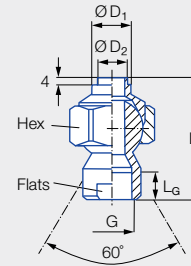
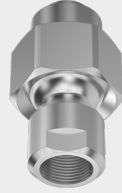

For all nozzles with	Ordering no.				G BSPP	Dimensions [mm]						Weight [g] (Brass)
	Type	Mat. no.		Code		L	L _G	Ø D ₁	Ø D ₂	Hex	Flats	
		16	30									
1/8" male thread	092.010	●	●	SB	1/8	43.0	8.0	18.0	12.0	24	13	70.0
1/4" male thread	092.020	●	●	SD	1/4	64.5	11.5	20.0	15.0	27	17	150.0
3/8" male thread	092.030	●	●	SF	3/8	59.0	12.0	22.0	15.0	30	19	165.0
1/2" male thread	092.040	●	●	SH	1/2	71.1	15.5	22.0	15.0	41	24	350.0
3/4" male thread	092.050	●	●	SL	3/4	74.8	17.0	22.0	18.0	46	30	470.0

Ball joints with welding connection and male thread

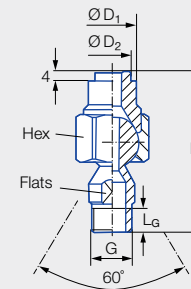
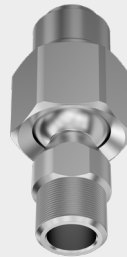

Series	Ordering no.				G BSPP	Dimensions [mm]						Weight [g]
	Type	Mat. no.		Code		L	L _G	Ø D ₁	Ø D ₂	Hex	Flats	
		16	Stainless steel 303/316Ti									
226/216/2TR/ 302/308/350/ 468/652/684/ 548/679	092.022	●		SE	3/8 A	68.0	10.0	20.0	15.0	27	17	155.0

Ordering Type + Material no. + Code = Ordering no.
example: 092.010 + 16 + SB = 092.010.16.SB

Accessories for nozzle series 676 with integrated ball joint



Threaded sockets

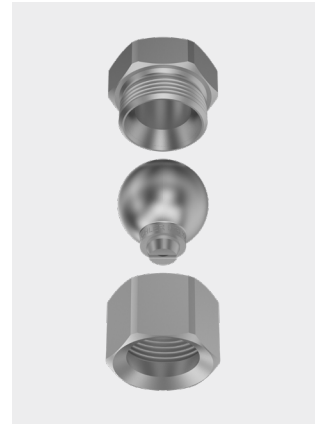
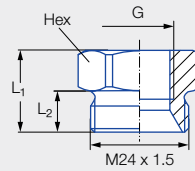
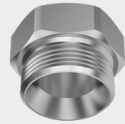

Series	Ordering no.		G BSPP	Dimensions [mm]			Weight [g] (Brass)	
	Type	Mat. no.		L ₁	L ₂	Hex		
		16						30
		Stainless steel 303	Brass					
676	092.020.xx.AF.03 ¹	●	●	3/8	20.0	10.0	27	50.0

¹ Replace "xx" by material no.

Threaded nipple

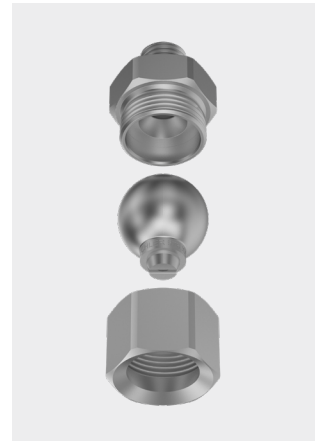
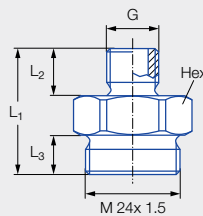
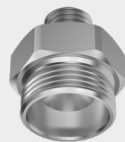

Series	Ordering no.		G BSPP	Dimensions [mm]			Weight [g] (Brass)		
	Type	Mat. no.		L ₁	L ₂	L ₃			
		16						30	
		Stainless steel 303	Brass						
676	092.024.xx.AC.03 ¹	●	●	1/4	32.0	12.0	10.0	27	70.0

¹ Replace "xx" by material no.

Order Type + Material no. = Ordering no.
example: 092.020.xx.AF.03 + 16 = 092.020.16.AF.03

Welded nipple

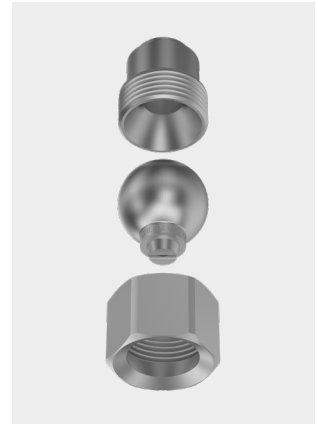
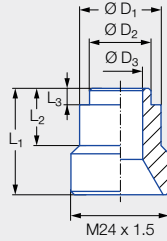

Series	Ordering no.		Dimensions [mm]						Weight [g]
	Type	Mat. no.	L ₁	L ₂	L ₃	Ø D ₁	Ø D ₂	Ø D ₃	
		17							
		Stainless steel 316Ti							
676	092.020.17.00.04	●	26.0	14.0	4.0	20.0	15.0	11.0	45.0

Retaining nuts

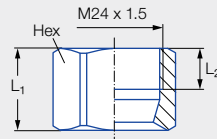
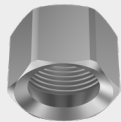

Series	Ordering no.		Dimensions [mm]				Weight [g] (Brass)
	Type	Mat. no.		L ₁	L ₂	Hex	
		16	30				
		Stainless steel 303	Brass				
676	092.020.xx.00.02 ¹	●	●	20.0	10.0	27	35.0

¹ Replace "xx" by material no.

Notice: The assembly accessories shown can be used with the low pressure flat fan nozzle with ball joint (series 676) (see Page 140/252).

Order Type + Material no. = Ordering no.
 example: 092.020.xx.00.02 + 16 = 092.020.16.00.02



Filter

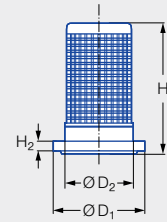

Series	Nozzle size	Ordering no.		Colour	Dimensions [mm]					Weight [g]
		Type	Mat. no.		Mesh size	H ₁	H ₂	Ø D ₁	Ø D ₂	
216/2TR/ 302/468/ 422 bayonet/ 652/646/684	xxx.32x-xxx.44x	065.257	● 56 POM	Blue	0.25	21.40	2.00	14.80	11.00	2.00
	xxx.48x-xxx.56x	065.256	●	Red	0.65	21.40	2.00	14.80	11.00	2.00

Filter

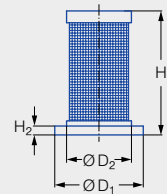

Series	Nozzle size	Ordering no.		Colour	Dimensions [mm]					Weight [g]
		Type	Mat. no.		Mesh size	H ₁	H ₂	Ø D ₁	Ø D ₂	
216/2TR/ 302/468/ 422 bayonet/ 652/646/684	xxx.32x-xxx.44x	095.016.53.15.62	● 53 Polypropylene	Light pink	0.08	21.00	1.60	15.00	11.00	1.00
		Strainer insert 304 SS								

Cup strainer

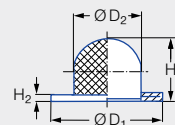

Series	Nozzle size	Ordering no.		Mesh size	Dimensions [mm]				Weight [g]
		Type	Mat. no.		H ₁	H ₂	Ø D ₁	Ø D ₂	
216/2TR/ 302/468/ 422 bayonet/ 652/646/684	xxx.32x-xxx.44x	065.252	● 26 Monel/Copper	0.5	8.5	1.6	14.8	9.0	1.0

Ordering Type + Material no. = Ordering no.
example: 065.257 + 56 = 065.257.56

Filters with ball-type non-return valve



Ball-type non-return valve
with integrated filter
 $P_{max} = 20 \text{ bar}$

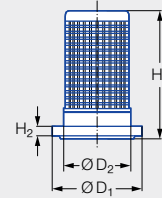

Series	Nozzle size	Ordering no.		Colour	Pressure [bar]		Dimensions [mm]					Weight [g]
		Type	Mat. no.		Opening pressure	Closing pressure	Mesh size	H ₁	H ₂	Ø D ₁	Ø D ₂	
			56									
216/2TR/ 302/468/ 422 bayonet/ 652/646/684	xxx.32x-xxx.44x	065.265 Ball 420 SS Spring 302 SS	●	Blue	0.40-0.50	0.35-0.45	0.25	21.40	2.00	14.80	11.00	2.00
	xxx.48x-xxx.56x	065.266 Ball 420 SS Spring 302 SS	●	Red	0.40-0.50	0.35-0.45	0.65	21.40	2.00	14.80	11.00	2.00

Ball-type non-return valve
with integrated filter

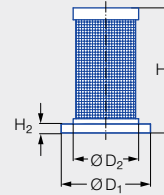

Series	Nozzle size	Ordering no.		Colour	Pressure [bar]		Dimensions [mm]					Weight [g]
		Type	Mat. no.		Opening pressure	Closing pressure	Mesh size	H ₁	H ₂	Ø D ₁	Ø D ₂	
			53									
216/2TR/ 302/468/ 422 bayonet/ 652/646/684	xxx.14x-xxx.36x	095.016.53.11.00 Strainer insert/ Ball 304 SS Spring 302 SS	●	Blue	approx. 0.50	approx. 0.30	0.08	21.00	1.60	15.00	11.00	2.00
	xxx.14x-xxx.36x	095.016.53.14.63 Strainer insert/ Ball 304 SS Spring 302 SS	●	Green	approx. 2.80	approx. 1.60	0.08	21.00	1.50	15.00	11.00	2.00

Ordering Type + Material no. = Ordering no.
example: 065.265 + 56 = 065.265.56

Retaining nuts and gaskets



Retaining nuts

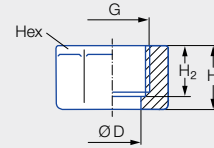
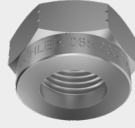

Series	Ordering no.						G BSPP	Dimensions [mm]				Weight [g] (Brass)	
	Type	Mat. no.						H ₁	H ₂	Ø D	Hex		
		16	17 ¹	1Y	30	56 Black							5E Blue
		Stainless steel 303	Stainless steel 316Ti	Stainless steel 316L	Brass	POM	PVDF						
226/2TR/ 468/652/660/ 684/548/679	065.200	●	●		●			3/8	13.0	10.0	12.8	22	25.0
	065.200					●	●	3/8	14.5	11.5	13.0	22	25.0
	069.000	●		●	●			UNF 11/16	14.3	9.7	13.1	20.6	25.0
656/657/ 664/665	065.600	●	●		●		●	3/4	16.0	13.0	20.1	32	60.0

¹ We reserve the right to supply material 316Ti or 316L under material no. 17.

Gaskets

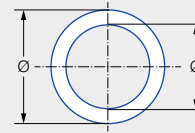

Series	Nozzle Code	Ordering no.				Dimensions [mm]	Weight [g]	
		Type	Mat. no.					
			55	71	72			73
		PTFE	Cu. ISO PL. 7504	EWP 210 (asbestos-free)	Soft rubber			
610	1/8 BSPP	061.040		●		Ø 10.00 x Ø 14.00 x 1.00	0.13	
220/612	1/4 BSPP	061.240	●	● ¹	●	Ø 13.20 x Ø 17.00 x 1.00	0.20	
490/491/ 460/461/ 616/617/689	3/4 BSPP	061.640		● ²	●	Ø 26.50 x Ø 32.00 x 1.00	0.50	
405	1 1/4 BSPP	062.140			●	Ø 42.00 x Ø 50.00 x 1.00	1.20	
405	2 BSPP	062.540			●	Ø 60.00 x Ø 70.00 x 2.00	3.92	
226/468/652/ 684/679	Retaining nut 3/8	065.240	●		●	Ø 11.00 x Ø 15.00 x 1.00	0.14	
656/657	Retaining nut 3/4	065.640			●	Ø 18.00 x Ø 24.00 x 1.00	0.50	
PTFE sealing tape For connecting cylindrical female threads and tapered male threads BSPT		095.009.55.09.30.0				12 mm x 0.1 mm x 12 m	-	

¹ Dimensions [mm] for mat. no. 71: 13.20 x 17.00 x 2.00.

² Dimensions [mm] for mat. no. 71: 26.50 x 32.00 x 2.50.

Ordering Type + Material no. = Ordering no.
example: 065.200 + 16 = 065.200.16

Strainers

Max. 12 bar



Standard strainer for industrial application

- For operating pressure levels up to 12 bar.
With large filter surfaces
- Mesh size is colour coded:
 - 0.6 mm = red
 - 0.3 mm = blue
 - 0.2 mm = green
- Easy handling
- Robust version
- Slender design

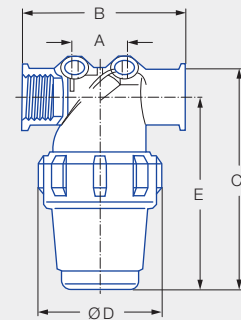

Type		Code BSPP	Dimensions [mm]					Weight [g]
			A	B	C	E	Ø D	
S.GA2.	S.GI2.	1/2	27.0	97.0	140.0	118.0	74.0	200.0
S.GA3.	S.GI3.	3/4	27.0	97.0	140.0	118.0	74.0	200.0
S.GA4.	S.GI4.	1	40.0	112.0	175.0	143.0	86.0	300.0
S.GA5.	S.GI5.	1 1/4	39.0	146.0	280.0	239.0	116.0	630.0
S.GA6.	S.GI6.	1 1/2	39.0	146.0	280.0	239.0	116.0	630.0

Pressure/Temperature ranges

Max. temperature [°C]	p _{max} [bar]
20	12
60	7

	Ordering no.			Standard strainer insert/Standard filter	
	Type	Size	Mat. no.	Mesh size [mm]	Type (blue)
			53 Polypropylene		
Male thread	S.GA2.	012.	●	0.3	S.000.012.00.26.03
	S.GA3.	034.	●	0.3	S.000.012.00.26.03
	S.GA4.	100.	●	0.3	S.000.100.00.26.03
	S.GA5.	114.	●	0.3	S.000.114.00.26.03
	S.GA6.	112.	●	0.3	S.000.114.00.26.03
Female thread	S.GI2.	012.	●	0.3	S.000.012.00.26.03
	S.GI3.	034.	●	0.3	S.000.012.00.26.03
	S.GI4.	100.	●	0.3	S.000.100.00.26.03
	S.GI5.	114.	●	0.3	S.000.114.00.26.03
	S.GI6.	112.	●	0.3	S.000.114.00.26.03

Optional strainer inserts			
Mesh size [mm]	Type (red)	Mesh size [mm]	Type (green)
0.6	S.000.012.00.26.06	0.2	S.000.012.00.26.02
0.6	S.000.012.00.26.06	0.2	S.000.012.00.26.02
0.6	S.000.100.00.26.06	0.2	S.000.100.00.26.02
0.6	S.000.100.00.26.06	0.2	S.000.100.00.26.02
0.6	S.000.114.00.26.06	0.2	S.000.114.00.26.02
0.6	S.000.114.00.26.06	0.2	S.000.114.00.26.02
0.6	S.000.012.00.26.06	0.2	S.000.012.00.26.02
0.6	S.000.012.00.26.06	0.2	S.000.012.00.26.02
0.6	S.000.012.00.26.06	0.2	S.000.012.00.26.02
0.6	S.000.100.00.26.06	0.2	S.000.100.00.26.02
0.6	S.000.100.00.26.06	0.2	S.000.100.00.26.02
0.6	S.000.114.00.26.06	0.2	S.000.114.00.26.02
0.6	S.000.114.00.26.06	0.2	S.000.114.00.26.02

Notice: Standard strainer insert (blue) included in the scope of supply.

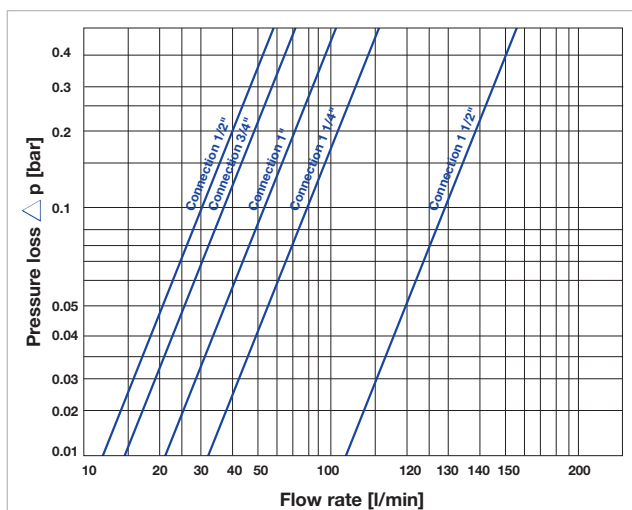

Correction factors for Δp

Viscosity [mPa·s]	Basket – mesh size [mm]		
	0.6	0.3	0.2
1.0 (water)	1.0	1.2	1.4
100.0	1.6	1.9	2.0
200.0	1.7	2.2	2.3

Ordering Type + Size + Material no. = Ordering no.
 example: S.GA2. + 012. + 53 = S.GA2.012.53

Strainers

Max. 8 bar



Strainer with high flow rate and low resistance

- Integrated flow deflector prevents clogging of the filter insert
- Dirt particles can be removed via an offset outlet port
- Prepared for the install of two pressure gauges

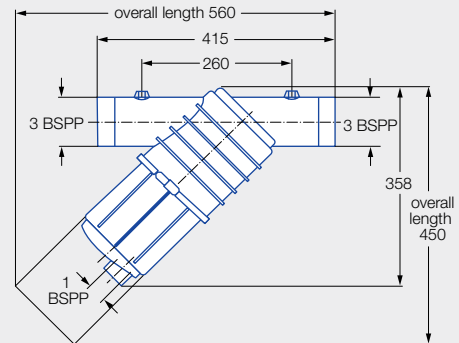

Strainer with screen

Type	Size	Ordering no.	Screen mesh size [µm/mesh]
		Mat. no.	
		53	
		Polypropylene	
S.GA2.	300.	●	594/32
S.GA3.	300.	●	365/50
S.GA4.	300.	●	173/100
S.GA5.	300.	●	144/120

Screen

Type	Size	Ordering no.		Screen mesh size [µm/mesh]
		Mat. no.		
		26	5A	
		Stainless steel 304	Polyester/ Stainless steel	
S.002.	300.00.	●		594/32
S.003.	300.00.	●		365/50
S.004.	300.00.	●		173/100
S.005.	300.00.		●	144/120

Pressure loss chart

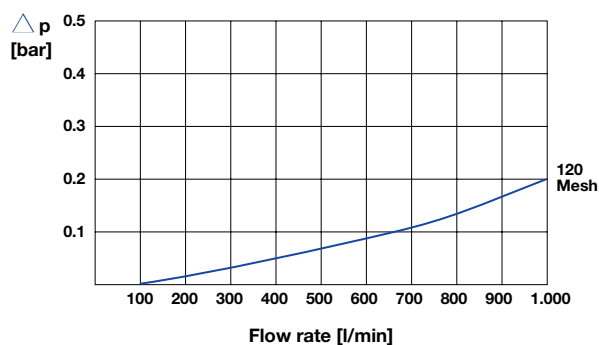

Technical data

Screening surface	860 cm ²
Screening insert Ø	145 mm
Height of screening insert	320 mm
Inflow/Outflow port Ø	3"
Pressure gauge connection Ø	1/4 BSPP
Max. operating pressure	8 bar

Ordering example for strainer:

Ordering Type + Size + Material no. = Ordering no.
 example: S.GA2. + 300. + 53 = S.GA2.300.53

Ordering example for strainer insert:

Ordering Type + Size + Material no. = Ordering no.
 example: S.002. + 300.00. + 26 = S.002.300.00.26

CONTACT: Lechler GmbH · Ulmer Strasse 128 · 72555 Metzingen, Germany · Phone +49 7123 962-0 · ind@lechler.de · www.lechler.com

